

NIBCO®



Copper Fittings Catalog

C-CF-0321

Wrot and Cast Pressure Fittings for
Potable Water Applications



QUALITY PRODUCTS SINCE 1904

A recognized brand leader bringing flow control products and technologies to market, NIBCO has a history of success and innovation in the plumbing industry.

Headquartered in Elkhart, Indiana, we operate multiple manufacturing plants and distribution centers strategically located throughout the United States and globally, and offer more than 36,000 SKUs, including our NIBCO® family brands, Webstone®, Chemtrol® and Sure Seal®.

We have vertically integrated manufacturing, distribution and networked communications to provide a seamless source of information and service, 24/7. We place great emphasis on personal connections with our factory direct sales, live customer service and technical service support. We also offer unique programs to support our customers' success, including our NIBCO Partner program, Vendor Managed Inventory and EDI for wholesalers.

More than 90 percent of NIBCO-branded products are manufactured in the U.S. using high-quality materials and innovative processes and technologies to improve product performance and quality. For every high-quality valve or fitting made at NIBCO, each is made with pride by the hundreds of NIBCO associates who work there.

Today, NIBCO is a fifth-generation, family- and associate-owned business. Since 1904, we've pioneered many products and processes. As the flow control industry continues to become more demanding, we remain focused on what has made us successful: delivering more than a product and making business better for each of our customers.

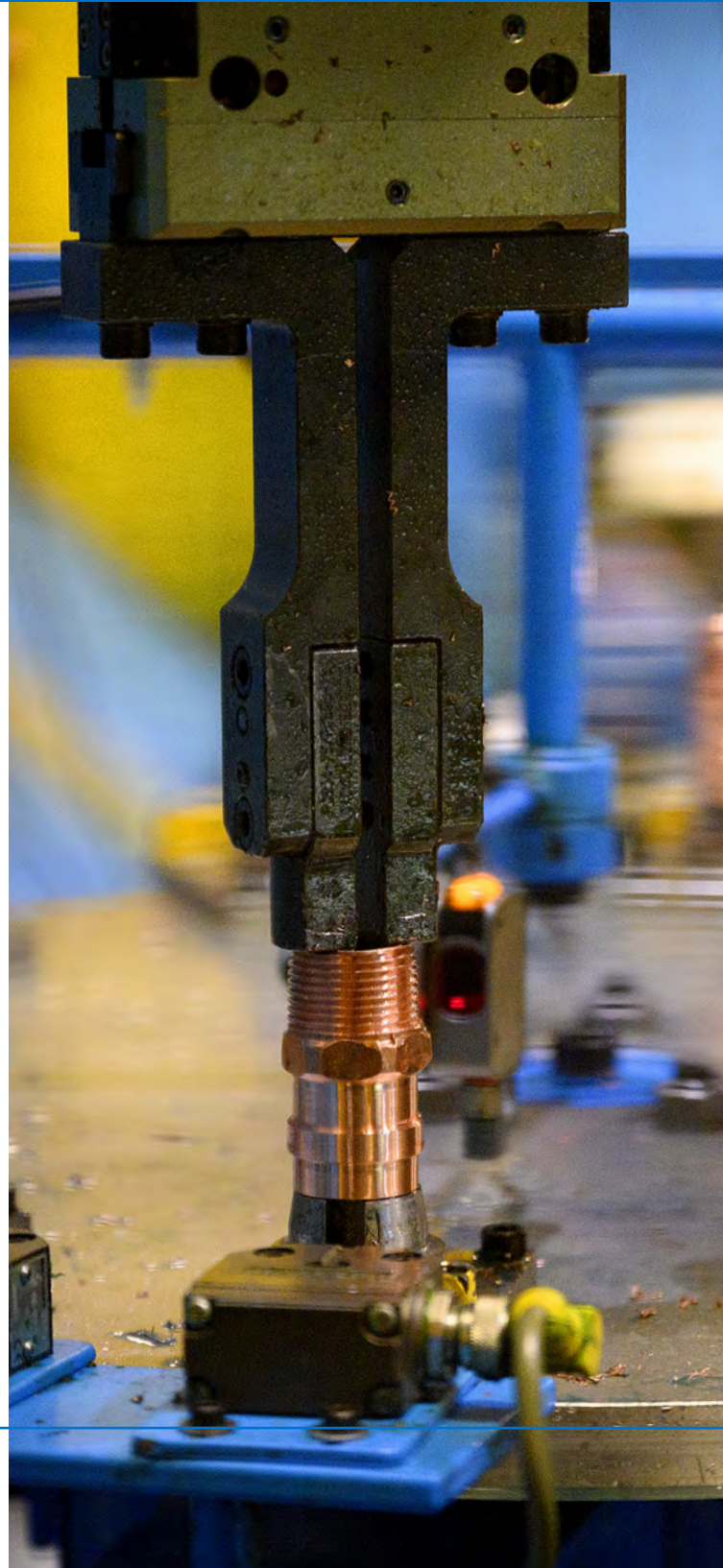

[VISIT OUR WEBSITE TO LEARN MORE](#)

Visit our website for the most current information.

Table of Contents

Specifications	4
Wrot & Cast Pressure Fittings	5-21
Cast Copper Alloy Flared Fittings	22-24
Wrot & Cast DWV Fittings	25-35
Engineering Data	36-45
Installation Instructions	46-48
Frequently-Asked Questions	49
Warranty	50
Numerical Index	51



The manufacturing plants at Stuarts Draft, VA, Nacogdoches, TX and Reynosa, Mexico manufacture products under a Quality Management System conforming to the current revision of ISO-9001 International Standards

Specifications

All of the advantages found in copper as a metal have been capitalized to the utmost in the manufacture of NIBCO® Fittings. Because of the accuracy of construction and design, copper plumbing is more efficient and less expensive.

NIBCO manufactures nine general types of fittings: Wrot Pressure; Cast Pressure; Wrot Drainage; Cast Drainage; Flanges; Flared Tube; Threaded Bronze; Insert Fittings for PEX; Barbed Insert Fittings for Polybutylene. Each has its particular place and use and each offers its own advantages when used for the proper service requirement.

Material & Construction — NIBCO Fittings are made from the highest quality raw materials — Cast Fittings are offered in traditional copper alloys C83600, and C84400 and high quality lead-free* dezincification-resistant (DZR) silicon bronze alloy C87850 cast or 69300 forged Performance Bronze™ per ASTM Specification B584. Wrot Copper Fittings are made from commercially pure copper mill products already meeting current lead-free* requirements per ASTM Specifications B75 Alloy C12200. Furthermore, solder-joint fittings are designed to be compatible with tubing compliant to ASTM B88 UNS Alloy C12200 (DHP); *Standard Specification for Seamless Copper Water Tube*., designated as types K, L, and M.

Lead Free refers to the wetted surface of pipe, fittings and fixtures in potable water systems that have a weighted average lead content ≤ 0.25%.

NIBCO Fittings are produced to meet the requirements of applicable standards.

The majority of NIBCO® brand wrot and cast fittings are manufactured in the U.S.A. and Mexico*. The manufacturing plants at Stuarts Draft, VA, Nacogdoches, TX and Reynosa, Mexico are registered to ISO 9001 quality standards.

Following is suggested phrasing to be incorporated in your specifications or bills of material for Copper Tube Fittings.

WROT SOLDER JOINT FITTINGS — "Solder Joint Fittings shall be produced to one of the following specifications:

1. "Material and workmanship shall be in accordance with ASME/ANSI B16.22; Wrought Copper and Copper Alloy Solder Joint Pressure Fittings."
2. "The dimensional, material and workmanship shall meet the requirements of MSS SP-104; Wrought Copper Solder Joint Pressure Fittings."
3. "The dimensional, material and workmanship of 5"-12" copper fittings shall meet the requirements of MSS SP-109 "Welded Fabricated Copper Solder Joint Pressure Fittings."
4. "Third party certified to NSF/ANSI/CAN-61."
5. "Lead-free* fittings are third party certified to NSF/ANSI/CAN-61."

CAST COPPER ALLOY SOLDER JOINT FITTINGS — "Cast Copper Alloy Solder Joint Fittings shall be in accordance with ASME B16.18."

WROT DRAINAGE FITTINGS — "Wrot Drainage Fittings shall be in accordance with ASME B16.29."

CAST COPPER ALLOY SOLDER JOINT DRAINAGE FITTINGS — "Cast Copper Alloy Solder Joint Drainage Fittings shall be in accordance with ASME B16.23."

CAST COPPER ALLOY FLARED TUBE FITTINGS — "Cast Copper Alloy Flared Tube Fittings shall be in accordance with ASME B16.26."

CAST COPPER ALLOY FLANGES AND FLANGED FITTINGS —

CLASS 150 — "Cast Copper Alloy Flanges and Flanged Fittings shall meet the requirements of MSS SP-106" and/or "the workmanship and dimensions of Federal Specifications WW-F-406 or ASME Std. B16.24."

CLASS 125 — Material, workmanship and dimensions of flanges shall be in accordance with MSS SP-106."

CAST BRONZE THREADED FITTINGS —

"Cast Bronze Threaded Fittings shall be in accordance with ASME B16.15."

POLYBUTYLENE COPPER INSERT TYPE VALVES AND FITTINGS — "Wrot Copper Insert Fittings shall be manufactured per MSS SP-103."

NIBCO® Copper Tube Fittings are all produced to above Standards. To simplify, write your specifications to read: "Copper Tube Fittings to be in accordance with specifications as outlined in NIBCO Copper Fittings Catalog."

WROT COPPER MEDICAL GAS SYSTEM COMPONENTS —

"Wrot copper fittings that are to be installed in medical gas applications shall be prepared in accordance with NFPA 99, Health Care Facilities Gas and Vacuum Systems and the Compressed Gas Association, Pamphlet G4.1. Packaging shall be adequately protective and include labeling that identifies the preparer and states that the product has been cleaned and bagged for oxygen or med gas service."

For technical information and dimensions refer to the engineering section contained in this catalog.

* NIBCO, may, from time to time, source and/or supplement a wrot or cast fitting product from suppliers outside of the U.S.A. and/or Mexico.

Visit our website for the most current information.

Wrot and Cast Pressure Fittings

600 Series – Wrot
700 Series – Cast

Adapters	6-8
Air Chambers	8
Bulkhead Fittings	8
Bushings	8
Caps	9
Couplings	9-10
Crosses	11
Elbows	11-14
Fitting Reducers	15
Flanges	15
Plugs	16
Return Bends	16
Straps & Hangers	16
Tees	16-20
Traps	20
Unions	21
Venturi	21
Y's	21



The manufacturing plants at Stuarts Draft, VA, Nacogdoches, TX and Reynosa, Mexico manufacture products under a Quality Management System conforming to the current revision of ISO-9001 International Standards

Visit our website for the most current information.

ADAPTERS

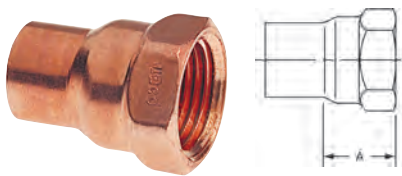

603
Adapter C x F – Wrot

NOM. SIZE	APPROX. NET WT./LBS.	DIM. A INCHES
1/8	0.03	13/32
1/8 x 1/4	0.03	1/2
1/4	0.03	5/8
1/4 x 3/8	0.04	11/16
3/8	0.04	11/16
3/8 x 1/4	0.03	9/16
3/8 x 1/2	0.09	29/32
3/8 x 3/4	0.10	1
1/2	0.08	27/32
1/2 x 1/4	0.06	1/2
1/2 x 3/8	0.04	17/32
1/2 x 3/4	0.14	1
5/8 x 1/2	0.11	3/4
5/8 x 3/4	0.13	29/32
3/4	0.15	29/32
3/4 x 1/2	0.10	5/8
3/4 x 1	0.21	11/8
1	0.24	31/32
1 x 1/2	0.14	5/8
1 x 3/4	0.19	25/32
1 x 1 1/4	0.28	17/32
1 1/4	0.33	13/32
1 1/4 x 1	0.28	29/32
1 1/4 x 1 1/2	0.40	1 1/4
1 1/2	0.44	1 1/8
1 1/2 x 1	0.43	25/32
1 1/2 x 1 1/4	0.47	1 1/32
1 1/2 x 2	0.78	1 1/32
2	0.63	1 3/32
2 x 1 1/2	0.74	1 11/32
2 1/2	1.15	1 3/16
3	1.88	1 5/16
4	3.14	1 7/8

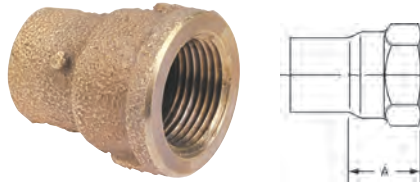

703 ⚠
Adapter C x F – Cast

NOM. SIZE	APPROX. NET WT./LBS.	DIM. A INCHES
1/4 x 1/2	0.13	27/32
▲ 1/2 x 1	0.28	1
▲ 3/4 x 3/8	0.17	3/4
3/4 x 1 1/4	0.54	1 1/8
▲ 1 x 1 1/2	0.68	1 3/32
1 1/4 x 3/4	0.29	1 3/16
1 1/4 x 2	0.98	1 5/32
2 x 1 1/4	0.81	27/32
2 1/2	1.62	1 3/8
3	2.34	1 1/2
4	4.23	1 9/16

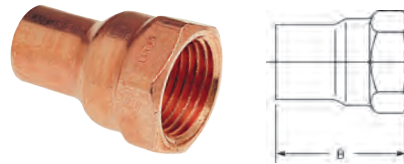

603-2
Fitting Adapter Ftg x F – Wrot

NOM. SIZE	APPROX. NET WT./LBS.	DIM. B INCHES
1/4	0.03	1 3/32
3/8	0.06	1 3/16
1/2	0.09	1 7/16
1/2 x 3/8	0.05	1 1/4
3/4	0.13	1 11/16
1	0.27	2 1/32
1 1/4	0.31	2 1/8
1 1/2	0.43	2 5/16
2	0.61	2 1/2
2 1/2	1.63	2 31/32
3	2.34	3 1/4

⚠ WARNING: This product can expose you to chemicals including lead, which is known to the State of California to cause cancer and birth defects or other reproductive harm. For more information go to www.P65Warnings.ca.gov.

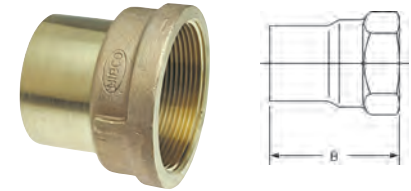

703-2 ⚠
Fitting Adapter Ftg x F – Cast

NOM. SIZE	APPROX. NET WT./LBS.	DIM. B INCHES
▲ 1/2 x 1/4	0.11	1 7/32
▲ 3/4 x 1/2	0.13	1 9/16
1 x 1/2	0.14	1 7/16
▲ 1 x 3/4	0.38	1 31/32
2 1/2	1.65	2 15/16
3	2.52	3 1/4

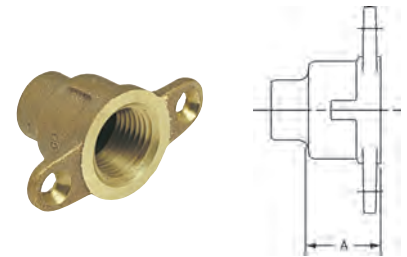

703-5 ⚠
Special Drop Adapter C x F – Cast

NOM. SIZE	APPROX. NET WT./LBS.	DIM. A INCHES
▲ 1/2	0.16	3/4
3/4	0.24	7/8

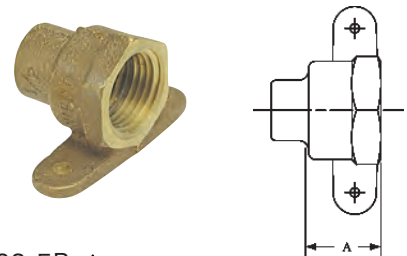

703-5B ⚠
Drop Adapter C x F – Cast

NOM. SIZE	APPROX. NET WT./LBS.	DIM. A INCHES
1/2	0.15	3/4

Consult price sheet for Made to Order items and for minimum order quantities.

▲ Also available in Lead-Free*. For additional details, see our Lead-Free* literature on www.nibco.com.

*Weighted average lead content ≤ 0.25%

Visit our website for the most current information.

ADAPTERS *continued*

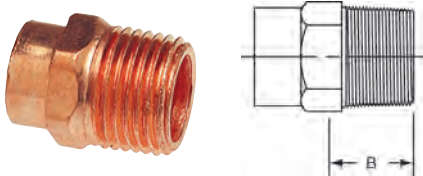

604
Adapter C x M – Wrot

NOM. SIZE	APPROX. NET WT./LBS.	DIM. B INCHES
1/8 x 1/4	0.03	7/16
1/4	0.03	23/32
1/4 x 1/2	0.09	1 1/16
3/8	0.04	19/32
3/8 x 1/4	0.06	1/2
3/8 x 1/2	0.09	1
3/8 x 3/4	0.15	1 5/16
1/2	0.07	5/8
1/2 x 1/4	0.05	5/8
1/2 x 3/8	0.05	19/32
1/2 x 3/4	0.14	31/32
1/2 x 1	0.25	1 1/2
5/8 x 1/2	0.08	3/4
5/8 x 3/4	0.16	1 1/8
3/4	0.14	13/16
3/4 x 1/2	0.10	27/32
3/4 x 1	0.26	1 7/16
1	0.21	31/32
1 x 1/2	0.19	31/32
1 x 3/4	0.18	29/32
1 x 1 1/4	0.38	1 1/2
1 x 1 1/2	0.46	1 7/32
1 1/4	0.35	1 5/16
1 1/4 x 3/4	0.30	31/32
1 1/4 x 1	0.25	1 5/32
1 1/4 x 1 1/2	0.51	1 19/32
1 1/2	0.46	31/32
1 1/2 x 1	0.44	1 3/32
1 1/2 x 1 1/4	0.38	1 3/16
1 1/2 x 2	0.76	1 1/8
2	0.73	1 3/32
2 x 1 1/2	0.58	1 11/32
2 1/2	1.19	1 27/32
3	1.39	2 1/8
4	3.19	–

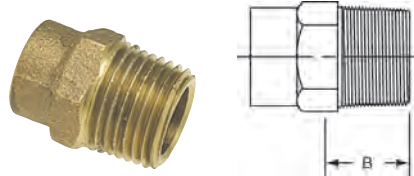

704 ⚠
Adapter C x M – Cast

NOM. SIZE	APPROX. NET WT./LBS.	DIM. B INCHES
3/4 x 3/8	0.16	13/16
▲ 3/4 x 1 1/4	0.38	1 7/32
3/4 x 1 1/2	0.59	1 17/32
1 x 1 1/2	0.64	2 9/32
1 x 2	1.14	1 5/8
1 1/4 x 2	0.87	1 9/32
2 x 1 1/4	1.08	1 5/16
2 x 2 1/2	1.57	1 15/32
2 1/2	1.49	1 17/32
2 1/2 x 2	1.83	1 11/16
3	1.97	1 1/2
4	3.66	1 11/16
5	8.60	2 5/8

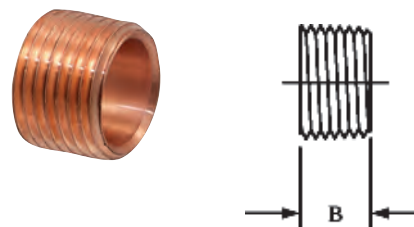

604-F
Flush Adapter C x M – Wrot

NOM. SIZE	APPROX. NET WT./LBS.	DIM. B INCHES
1/2	0.03	9/16
3/4	0.03	1 9/32

⚠ WARNING: This product can expose you to chemicals including lead, which is known to the State of California to cause cancer and birth defects or other reproductive harm. For more information go to www.P65Warnings.ca.gov.

▲ Also available in Lead-Free*. For additional details, see our Lead-Free* literature on www.nibco.com.

*Weighted average lead content ≤ 0.25%

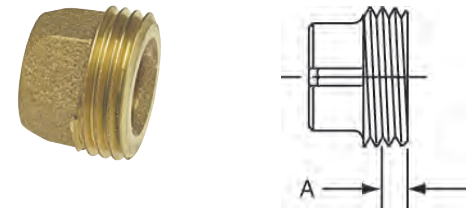

704-H ⚠
H o s e Adapter C x Hose – Cast

NOM. SIZE	APPROX. NET WT./LBS.	DIM. A INCHES
1/2	0.09	3/16

NOTE: Fits 1/2", 5/8" and 3/4" Garden Hose.

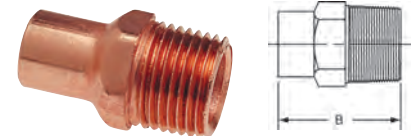

604-2
Fitting Adapter Ftg x M – Wrot

NOM. SIZE	APPROX. NET WT./LBS.	DIM. B INCHES
1/4	0.03	1 1/8
3/8	0.04	1 1/4
1/2	0.09	1 15/32
1/2 x 3/8	0.05	1 11/32
1/2 x 3/4	0.16	1 13/16
3/4	0.17	1 15/16
3/4 x 1/2	0.12	1 21/32
1	0.25	2 1/4
1 1/4	0.45	2 11/16
1 1/2	0.55	2 15/16
2	0.83	2 3/4
2 1/2	0.58	3 3/16
3	1.81	3 9/16

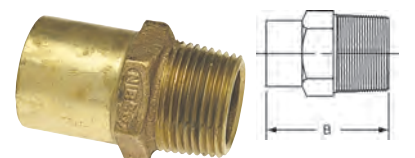

704-2 ⚠
Fitting Adapter Ftg x M – Cast

NOM. SIZE	APPROX. NET WT./LBS.	DIM. B INCHES
3/4 x 1	0.27	1 31/32
1 x 3/4	0.20	1 15/16
1 1/2	0.54	2 13/32
2	0.89	2 3/4

Consult price sheet for Made to Order items and for minimum order quantities.

Visit our website for the most current information.

ADAPTERS *continued*

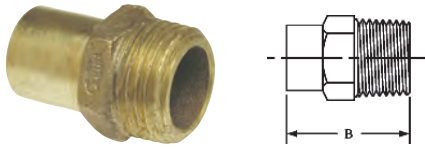

704-2-H 
Hose Adapter Ftg x Hose – Cast

NOM. SIZE	APPROX. NET WT./LBS.	DIM. B INCHES
3/4 F x 3/4 H	0.16	1 ⁵ / ₈

NOTE: Fits 1/2", 5/8" and 3/4" Garden Hose.

AIR CHAMBERS

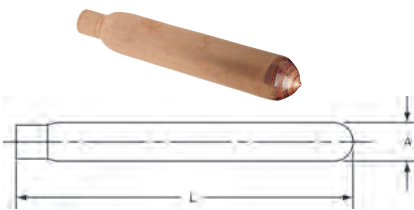

619
Air Chamber Ftg. – Wrot

NOM. SIZE	APPROX. NET WT./LBS.	DIM. A INCHES	DIM. L INCHES
1/2 x 6	0.20	1	6
1/2 x 12	0.41	1	12
1/2 x 14	0.76	1 ¹ / ₈	14



620-L
Air Chamber or Stub-Out Ftg. – Wrot

As Air Chamber, just solder one joint. When used as Stub-Out, simply pressure test system then cut off stub-out (save piece for future use) and install valve or fixture.

NOM. SIZE	APPROX. NET WT./LBS.	DIM. L INCHES
1/2 x 6	0.14	6
1/2 x 8	0.19	8
1/2 x 10	0.24	10
1/2 x 12	0.28	12
3/4 x 12	0.46	12

BULKHEAD FITTINGS

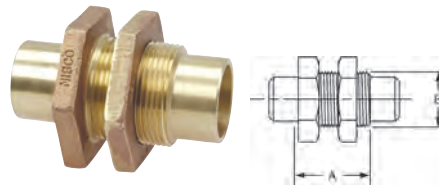

750 
Bulkhead Fitting C x C – Cast

NOM. SIZE	APPROX. NET WT./LBS.	DIM. A INCHES	DIM. B INCHES
1/2	0.48	1 ¹ / ₄	1
3/4	0.77	1 ⁹ / ₃₂	1 ¹ / ₄
1	1.30	1 ¹ / ₂	1 ⁵ / ₈
1 1/2	2.87	1 ¹ / ₂	2 ³ / ₈
2	3.65	2 ¹ / ₃₂	2 ⁵ / ₈

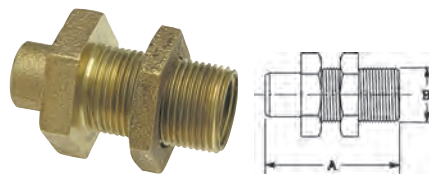

750-3 
Bulkhead Fitting C x F – Cast

NOM. SIZE	APPROX. NET WT./LBS.	DIM. A INCHES	DIM. B INCHES
1/2	0.50	2 ⁷ / ₁₆	1
3/4	0.79	2 ¹³ / ₁₆	1 ¹ / ₄
1	1.39	3 ³ / ₈	1 ⁵ / ₈

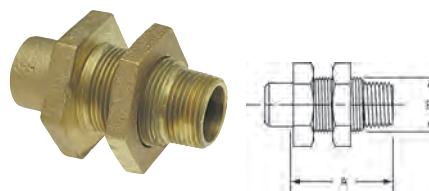

750-4 
Bulkhead Fitting C x M – Cast

NOM. SIZE	APPROX. NET WT./LBS.	DIM. A INCHES	DIM. B INCHES
1/2	0.51	1 ³¹ / ₃₂	1
3/4	0.79	2 ⁵ / ₃₂	1 ¹ / ₄

 **WARNING:** This product can expose you to chemicals including lead, which is known to the State of California to cause cancer and birth defects or other reproductive harm. For more information go to www.P65Warnings.ca.gov.

BUSHINGS



618
Flush Bushing Ftg x C – Wrot

NOM. SIZE	APPROX. NET WT./LBS.	DIM. C INCHES
1/4 x 1/8	0.01	3/32
3/8 x 1/4	0.01	3/16
1/2 x 1/4	0.04	9/32
1/2 x 3/8	0.02	3/16
5/8 x 1/2	0.03	3/32
3/4 x 3/8	0.11	15/32
3/4 x 1/2	0.08	11/32
3/4 x 5/8	0.04	7/32
1 x 1/2	0.22	15/32
1 x 3/4	0.12	7/32
1 1/4 x 1	0.17	5/32
1 1/2 x 1 1/4	0.22	1/4
2 x 1 1/2	0.66	5/16



618-3
Flush Bushing Ftg x F – Wrot

NOM. SIZE	APPROX. NET WT./LBS.	DIM. B INCHES
1/2 x 1/8	0.04	9/16
1/2 x 1/4	0.02	9/16
3/4 x 3/8	0.06	13/16
1 x 1/2	0.12	31/32
1 1/2 x 1	0.25	1 ⁵ / ₃₂



718-3 
Flush Bushing Ftg x F – Cast

NOM. SIZE	APPROX. NET WT./LBS.	DIM. B INCHES
1 1/4 x 3/4	0.18	1 ¹ / ₃₂

Consult price sheet for Made to Order items and for minimum order quantities.

Visit our website for the most current information.

CAPS

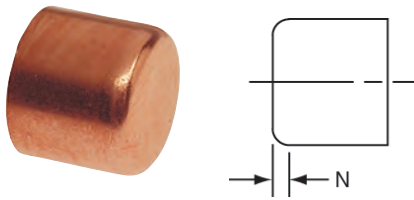

617
Tube Cap C – Wrot

NOM. SIZE	APPROX. NET WT./LBS.	DIM. N INCHES
1/8	0.00	1/32
1/4	0.01	1/16
3/8	0.01	3/32
1/2	0.02	1/8
5/8	0.03	1/8
3/4	0.05	3/16
1	0.07	5/32
1 1/4	0.10	3/32
1 1/2	0.16	1/8
2	0.27	5/32
2 1/2	0.47	7/32
3	0.78	7/32
4	1.66	1/4

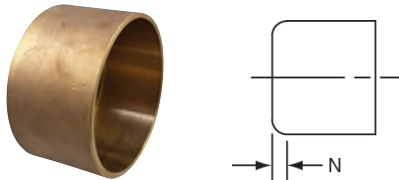

717 ⚠
Tube Cap C – Cast

NOM. SIZE	APPROX. NET WT./LBS.	DIM. N INCHES
5	5.48	7/16
6	9.07	17/32

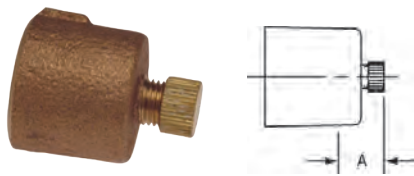

717-D ⚠
Drain Cap – Cast

NOM. SIZE	APPROX. NET WT./LBS.	DIM. A INCHES
1/2	0.06	21/32

Consult price sheet for Made to Order items and for minimum order quantities.

COUPLINGS

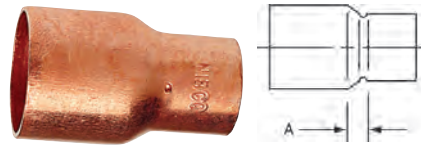

600
Reducing Coupling C x C – Wrot

NOM. SIZE	APPROX. NET WT./LBS.	DIM. A INCHES
1/8 x 3/16 O.D.	0.00	5/32
5/16 O.D. x 1/8	0.01	1/4
1/4 x 5/16 O.D.	0.01	3/16
1/4 x 1/8	0.01	3/16
3/8 x 1/4	0.02	3/16
3/8 x 5/16 O.D.	0.01	1/4
3/8 x 1/8	0.01	1/4
1/2 x 1/8	0.03	11/32
1/2 x 1/4	0.02	1/4
1/2 x 3/8	0.02	3/16
5/8 x 1/4	0.03	13/32
5/8 x 3/8	0.04	11/32
5/8 x 1/2	0.05	3/16
3/4 x 1/4	0.05	11/32
3/4 x 3/8	0.06	3/8
3/4 x 1/2	0.06	7/16
3/4 x 5/8	0.07	3/16
1 x 3/8	0.10	13/32
1 x 1/2	0.10	11/32
1 x 5/8	0.10	3/8
1 x 3/4	0.11	11/32
1 1/4 x 1/2	0.14	7/16
1 1/4 x 5/8	0.18	19/32
1 1/4 x 3/4	0.18	17/32
1 1/4 x 1	0.16	5/16
1 1/2 x 1/2	0.19	1/2
1 1/2 x 3/4	0.20	3/8
1 1/2 x 1	0.22	9/16
1 1/2 x 1 1/4	0.23	5/16
2 x 1/2	0.38	23/32
2 x 3/4	0.36	17/32
2 x 1	0.37	7/16
2 x 1 1/4	0.37	11/16
2 x 1 1/2	0.41	9/16
2 1/2 x 1	0.58	29/32
2 1/2 x 1 1/4	0.57	13/16
2 1/2 x 1 1/2	0.56	11/16
2 1/2 x 2	0.59	1/2

Continues...

⚠ WARNING: This product can expose you to chemicals including lead, which is known to the State of California to cause cancer and birth defects or other reproductive harm. For more information go to www.P65Warnings.ca.gov.

NOM. SIZE	APPROX. NET WT./LBS.	DIM. A INCHES
3 x 1 1/2	0.92	1 1/32
3 x 2	1.06	15/16
3 x 2 1/2	0.98	1/2
3 1/2 x 3	1.52	17/32
4 x 2	1.89	1 1/4
4 x 2 1/2	1.78	1
4 x 3	1.93	27/32
4 x 3 1/2	2.12	19/32
5 x 2	2.94	2 1/32
5 x 2 1/2	3.00	1 15/16
5 x 3	3.01	1 11/16
5 x 4	3.30	1 1/4
6 x 2	4.41	2 9/16
6 x 2 1/2	4.48	2 7/16
6 x 3	4.54	2 1/4
6 x 4	4.94	1 3/4
6 x 5	5.40	1 3/8
8 x 2 1/2	12.67	3 3/8
8 x 3	11.80	3 3/32
8 x 4	12.22	2 19/32
8 x 6	13.07	1 19/32

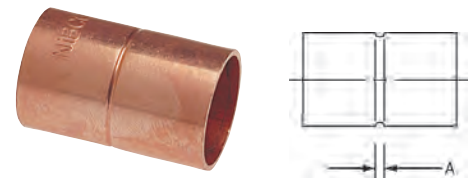

600-RS
Coupling with Rolled Tube Stop
C x C – Wrot

NOM. SIZE	APPROX. NET WT./LBS.	DIM. A INCHES
3/16 O.D.	0.00	3/32
1/8	0.01	3/32
5/16 O.D.	0.01	3/32
1/4	0.01	3/32
3/8	0.01	3/32
1/2	0.03	3/32
5/8	0.04	3/32
3/4	0.06	3/32
7/8	0.09	3/32
1	0.11	3/32
1 1/4	0.15	1/8
1 1/2	0.22	1/8
2	0.40	1/8
2 1/2	0.66	1/8
3	1.00	1/8
3 1/2	1.45	5/32
4	1.93	7/32

Visit our website for the most current information.

COUPLINGS *continued*

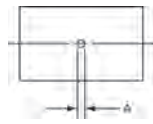

600-DS
Coupling with Dimpled Tube Stop
C x C – Wrot

NOM. SIZE	APPROX. NET WT./LBS.	DIM. A INCHES
3/16 O.D.	0.00	3/32
1/8	0.01	1/16
5/16 O.D.	0.01	3/32
1/4	0.01	1/16
3/8	0.01	3/32
1/2	0.03	3/32
5/8	0.04	3/32
3/4	0.06	3/32
7/8	0.09	3/32
1	0.11	3/32
1 1/4	0.15	1/8
1 1/2	0.22	1/8
2	0.40	1/8
2 1/2	0.66	1/8
3	1.00	1/8
3 1/2	1.45	5/32
4	1.93	7/32
5	3.53	7/32
6	5.63	7/32
8	14.48	15/32

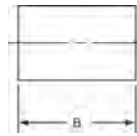

601
Coupling without Stop
C x C – Wrot

NOM. SIZE	APPROX. NET WT./LBS.	DIM. B INCHES
1/4	0.01	11/16
3/8	0.01	3/4
1/2	0.03	1
5/8	0.04	1 1/4
3/4	0.06	1 1/2
1	0.11	1 13/16
1 1/4	0.15	1 15/16
1 1/2	0.22	2 3/16
2	0.40	2 11/16
2 1/2	0.66	2 15/16
3	1.00	3 5/16
3 1/2	1.40	3 13/16
4	1.84	4 5/16
5	3.50	5 5/16
6	5.60	6 3/16
8	13.69	8 3/32

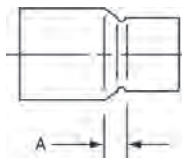

701 ⚠
Reducing Coupling C x C – Cast

NOM. SIZE	APPROX. NET WT./LBS.	DIM. A INCHES
3 x 1 1/4	1.54	23/32
3 x 1	1.64	27/32

⚠ WARNING: This product can expose you to chemicals including lead, which is known to the State of California to cause cancer and birth defects or other reproductive harm. For more information go to www.P65Warnings.ca.gov.

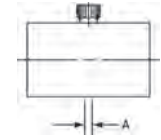

701-D ⚠
Drain Coupling C x C – Cast

NOM. SIZE	APPROX. NET WT./LBS.	DIM. A INCHES
▲ 1/2	0.08	1/4
▲ 3/4	0.09	1/4
1	0.22	1/4

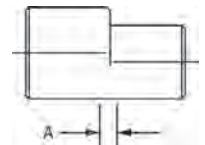

702 ⚠
Eccentric Coupling C x C – Cast

NOM. SIZE	APPROX. NET WT./LBS.	DIM. A INCHES
3/4 x 1/2	0.12	7/32
1 x 3/4	0.18	1/4
1 1/4 x 1	0.25	1/4
1 1/4 x 3/4	0.24	9/32

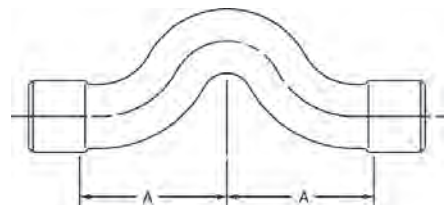

736 ⚠
Cross-Over Coupling
C x C – Cast

NOM. SIZE	APPROX. NET WT./LBS.	DIM. A INCHES
1/2	0.27	17/16
3/4	0.60	1 29/32

Consult price sheet for Made to Order items and for minimum order quantities.

▲ Also available in Lead-Free*. For additional details, see our Lead-Free* literature on www.nibco.com.

*Weighted average lead content ≤ 0.25%

Visit our website for the most current information.

CROSSES

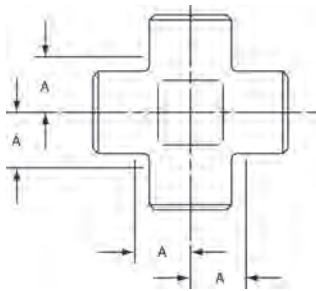

735 ⚠
Cross C x C x C x C –
Cast

NOM. SIZE	APPROX. NET WT./LBS.	DIM. A INCHES
▲ 3/8	0.08	5/16
▲ 1/2	0.14	7/16
▲ 3/4	0.28	9/16
1	0.54	23/32
1 1/4	0.78	7/8
1 1/2	1.05	1
2	2.00	1 1/4

⚠ WARNING: This product can expose you to chemicals including lead, which is known to the State of California to cause cancer and birth defects or other reproductive harm. For more information go to www.P65Warnings.ca.gov.

▲ Also available in Lead-Free*. For additional details, see our Lead-Free* literature on www.nibco.com.

*Weighted average lead content ≤ 0.25%

Consult price sheet for Made to Order items and for minimum order quantities.
Visit our website for the most current information.

ELBOWS

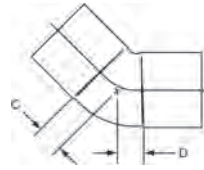

606
45° Elbow C x C – Wrot

NOM. SIZE	APPROX. NET WT./LBS.	DIM. C INCHES	DIM. D INCHES
1/8	0.01	11/32	11/32
1/4	0.02	9/32	9/32
3/8	0.03	3/16	3/16
1/2	0.04	9/32	9/32
5/8	0.09	11/32	11/32
3/4	0.09	11/32	11/32
7/8	0.20	11/16	11/16
1	0.15	3/8	3/8
1 1/4	0.22	17/32	17/32
1 1/2	0.35	19/32	19/32
2	0.65	25/32	25/32
2 1/2	1.07	29/32	29/32
3	1.58	1 1/8	1 1/8
3 1/2	3.35	1 5/16	1 5/16
4	3.35	1 9/16	1 9/16
5	5.57	1 9/16	1 9/16
6	9.57	2	2
8	23.00	2 9/32	2 9/32

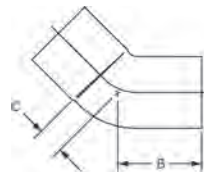
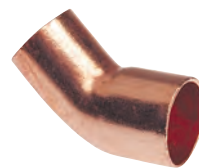

606-2
45° Fitting Elbow Ftg x C – Wrot

NOM. SIZE	APPROX. NET WT./LBS.	DIM. B INCHES	DIM. C INCHES
1/4	0.02	9/16	1/4
3/8	0.02	21/32	3/16
1/2	0.04	3/4	7/32
5/8	0.08	1 1/8	13/32
3/4	0.10	1 1/16	5/16
1	0.16	1 9/32	15/32
1 1/4	0.22	1 19/32	17/32
1 1/2	0.35	1 25/32	19/32
2	0.65	2 3/16	25/32
2 1/2	1.06	2 3/16	29/32
3	1.55	2 19/32	15/32
4	3.35	3 3/16	1 1/4

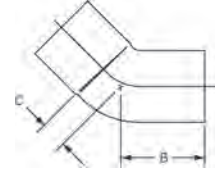

706-2 ⚠
45° Fitting Elbow Ftg x C – Cast

NOM. SIZE	APPROX. NET WT./LBS.	DIM. B INCHES	DIM. C INCHES
4	4.31	3 11/32	1 5/16

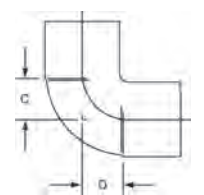

607
90° Elbow – Close Rough
C x C – Wrot

NOM. SIZE	APPROX. NET WT./LBS.	DIM. C INCHES	DIM. D INCHES
1/8	0.02	13/32	13/32
1/4	0.02	3/8	3/8
3/8	0.03	1/2	1/2
3/8 x 1/4	0.02	7/16	7/16
1/2	0.04	11/32	11/32
1/2 x 3/8	0.04	7/16	21/32
5/8 x 3/8	0.107	3/4	1 1/4
3/4	0.10	1/2	1/2
3/4 x 1/2	0.10	9/16	25/32
3/4 x 5/8	0.11	13/16	29/32
7/8	0.20	29/32	29/32
1	0.18	21/32	21/32
1 x 1/2	0.18	27/32	17/32
1 x 3/4	0.20	27/32	1 1/16
1 1/4	0.27	15/16	15/16
1 1/4 x 1	0.23	1 5/8	1 15/32
1 1/2	0.42	1	1
1 1/2 x 1 1/4	0.35	1 5/32	13/32
2	0.80	1 7/16	1 7/16
2 x 1 1/2	0.58	1 7/16	1 1/4
2 1/2	1.41	1 5/8	1 5/8
3	2.18	2	2
3 1/2	2.94	2 7/16	2 7/16
4	4.23	2 15/32	2 15/32
5	7.17	3 1/32	3 1/32
6	10.95	3 5/8	3 5/8
8	27.00	4 21/32	4 21/32

ELBOWS *continued*

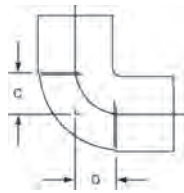

707 ▲
90° Elbow – Close Rough
C x C – Cast

NOM. SIZE	APPROX. NET WT./LBS.	DIM. C INCHES	DIM. D INCHES
1 1/4 x 1/2	0.28	15/32	27/32
▲ 1 1/4 x 3/4	0.34	9/16	13/16
1 1/4 x 1	0.42	11/16	13/16
▲ 1 1/2 x 1	0.46	11/16	1
1 1/2 x 3/4	0.45	19/32	31/32
1 1/2 x 1/2	0.40	5/8	29/32
2 x 1 1/4	0.86	7/8	1 1/4
2 x 1	0.78	3/4	1 1/4
2 x 3/4	0.69	19/32	1 1/4
2 1/2 x 2	2.16	1 1/4	1 1/2
3 x 2 1/2	2.26	1 11/16	1 1/2
3 x 2	2.68	1 3/8	1 9/16
4 x 3	5.18	1 29/32	2 15/32

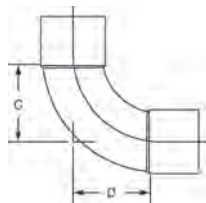

607-1
90° Elbow – Intermediate Radius
C x C – Wrot

NOM. SIZE	APPROX. NET WT./LBS.	DIM. C INCHES	DIM. D INCHES
1/2	0.05	19/32	19/32
5/8	0.09	7/8	7/8
3/4	0.14	13/16	13/16
1	0.24	1 1/16	1 1/16

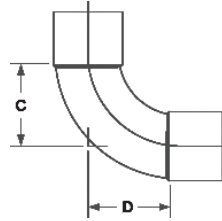

607-LT
90° Elbow – Long Radius
C x C – Wrot

NOM. SIZE	APPROX. NET WT./LBS.	DIM. C INCHES	DIM. D INCHES
3/16 O.D.	0.01	13/32	13/32
1/8	0.02	1/2	1/2
5/16 O.D.	0.02	9/16	9/16
1/4	0.02	3/4	3/4
1/4 x 1/8	0.01	19/32	1/2
3/8	0.04	23/32	23/32
1/2	0.07	29/32	29/32
1/2 x 3/8	0.06	13/16	13/16
1/2 x 1/4	0.03	25/32	21/32
5/8	0.11	13/32	13/32
5/8 x 1/2	0.09	1 1/16	1 1/16
3/4	0.16	1 1/8	1 1/8
3/4 x 5/8	0.13	1 1/4	1 3/32
3/4 x 1/2	0.10	1 1/8	1 1/16
7/8	0.28	1 19/32	1 19/32
1	0.28	1 7/16	1 7/16
1 x 3/4	0.20	1 1/4	1 1/8
1 x 5/8	0.15	1 13/32	1 3/32
1 1/4	0.42	1 7/8	1 7/8
1 1/4 x 1	0.33	1 25/32	1 1/2
1 1/2	0.66	2 1/4	2 1/4
2	1.23	2 15/16	2 15/16
2 1/2	2.15	3 11/16	3 11/16
2 1/2 x 2	1.53	3 11/16	3 11/16
3	2.93	4 1/32	4 1/32
3 1/2	4.46	5 7/16	5 7/16
4	5.96	5 1/4	5 1/4

▲ **WARNING:** This product can expose you to chemicals including lead, which is known to the State of California to cause cancer and birth defects or other reproductive harm. For more information go to www.P65Warnings.ca.gov.

▲ Also available in Lead-Free*. For additional details, see our Lead-Free* literature on www.nibco.com.

*Weighted average lead content ≤ 0.25%

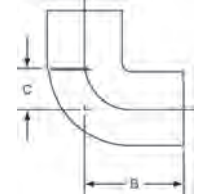

607-2
90° Fitting Elbow – Close Rough
Ftg x C – Wrot

NOM. SIZE	APPROX. NET WT./LBS.	DIM. B INCHES	DIM. C INCHES
1/8	0.01	13/32	1/2
1/4	0.02	3/4	3/8
3/8	0.03	15/16	1/2
1/2	0.04	31/32	3/8
3/4	0.11	1 11/32	17/32
1	0.20	1 3/4	27/32
1 1/4	0.28	2 3/32	15/16
1 1/2	0.43	2 11/32	1 1/32
2	0.82	2 29/32	1 3/8
2 1/2	1.39	3 7/32	1 19/32
3	2.09	3 13/16	2 3/32
4	4.00	4 3/4	2 15/32

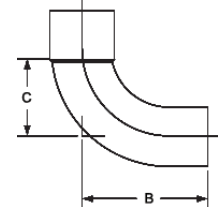

607-2-1
90° Fitting Elbow – Intermediate Radius
Ftg x C – Wrot

NOM. SIZE	APPROX. NET WT./LBS.	DIM. B INCHES	DIM. C INCHES
1/2	0.05	15/32	19/32
5/8	0.09	19/16	7/8
3/4	0.14	1 5/8	13/16
1	0.24	2 1/32	1 1/16

Consult price sheet for Made to Order items and for minimum order quantities.

Visit our website for the most current information.

ELBOWS *continued*

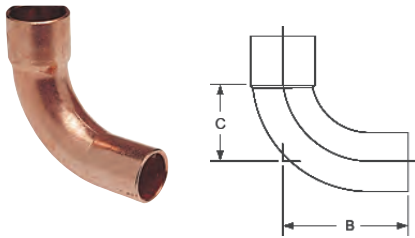

607-2-LT
90° Fitting Elbow – Long Radius
Ftg x C – Wrot

NOM. SIZE	APPROX. NET WT./LBS.	DIM. B INCHES	DIM. C INCHES
1/8	0.01	13/16	1/2
1/4	0.02	1 1/8	3/4
3/8	0.05	1 1/8	7/8
1/2	0.08	1 9/16	1 3/32
1/2 x 3/8	0.06	1 3/16	3/4
5/8	0.11	1 25/32	1 3/32
3/4	0.16	1 15/16	1 1/8
1	0.32	2 1/2	1 21/32
1 1/4	0.47	2 31/32	1 7/8
1 1/2	0.66	3 13/32	2 1/4
2	1.27	4 11/32	2 15/16
2 1/2	2.16	5 7/32	3 11/16
3	3.10	5 3/4	4 1/32
4	7.80	–	–

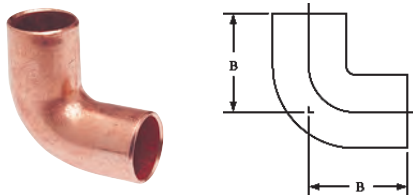

607-2-2
90° Fitting Elbow – Close Rough
Ftg x Ftg – Wrot

NOM. SIZE	APPROX. NET WT./LBS.	DIM. B INCHES
1/2	0.04	1 3/8
3/4	0.09	1 15/32
1	0.20	1 23/32
1 1/4	0.31	2 1/8
1 1/2	0.46	2 11/32
2	0.82	2 27/32
3	2.12	3 7/8

Consult price sheet for Made to Order items and for minimum order quantities.

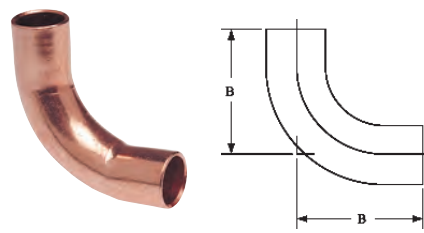

607-2-2-LT
90° Fitting Elbow – Long Radius
Ftg x Ftg – Wrot

NOM. SIZE	APPROX. NET WT./LBS.	DIM. B INCHES
1/4	0.02	27/32
3/8	0.04	1 1/8
1/2	0.08	1 19/32
5/8	0.11	1 25/32
3/4	0.14	1 3/4
1	0.31	2 1/2
1 1/4	0.43	2 29/32
1 1/2	0.65	3 7/16
2	1.25	4 11/32

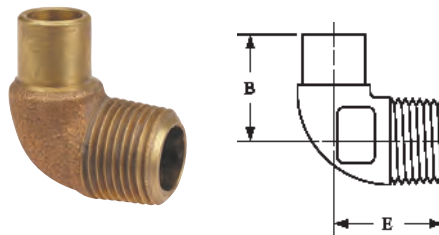

707-2-4 ⚠️
90° Fitting Elbow
Ftg x M – Cast

NOM. SIZE	APPROX. NET WT./LBS.	DIM. B INCHES	DIM. E INCHES
1/2	0.13	1 1/16	1 3/32

⚠️ WARNING: This product can expose you to chemicals including lead, which is known to the State of California to cause cancer and birth defects or other reproductive harm. For more information go to www.P65Warnings.ca.gov.

▲ Also available in Lead-Free*. For additional details, see our Lead-Free* literature on www.nibco.com.

*Weighted average lead content ≤ 0.25%

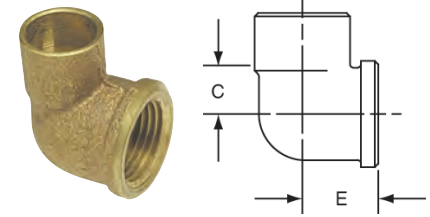

707-3 ⚠️
90° Elbow C x F – Cast

NOM. SIZE	APPROX. NET WT./LBS.	DIM. C INCHES	DIM. E INCHES
▲ 1/4	0.06	13/32	9/16
▲ 3/8	0.09	7/16	11/16
3/8 x 1/2	0.13	9/16	13/16
▲ 1/2	0.19	9/16	27/32
▲ 1/2 x 1/4	0.10	3/8	23/32
▲ 1/2 x 3/8	0.09	9/16	25/32
▲ 1/2 x 3/4	0.18	11/16	15/16
▲ 3/4	0.18	21/32	31/32
▲ 3/4 x 1/2	0.16	9/16	15/16
▲ 3/4 x 1	0.36	13/16	1 1/8
▲ 1	0.47	25/32	1 1/4
▲ 1 x 1/2	0.32	9/16	1 1/8
▲ 1 x 3/4	0.40	11/16	1 3/16
▲ 1 1/4	0.67	1	1 1/2
1 1/4 x 3/4	0.47	9/16	1 11/16
▲ 1 1/2	0.90	1 1/8	1 5/8
▲ 2	1.46	1 3/8	1 15/16

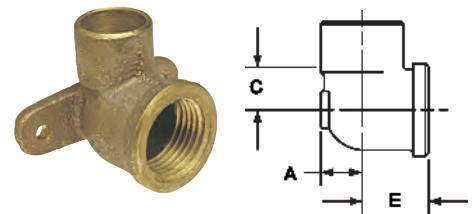

707-3-5 ⚠️
90° Drop Elbow C x F – Cast

NOM. SIZE	APPROX. NET WT./LBS.	DIM. A INCHES	DIM. C INCHES	DIM. E INCHES
3/8	0.12	11/32	7/16	11/16
3/8 x 1/2	0.18	11/32	9/16	13/16
▲ 1/2	0.18	13/32	9/16	27/32
▲ 1/2 x 3/8	0.11	3/8	1/2	3/4
▲ 3/4	0.32	7/32	11/16	31/32
▲ 3/4 x 1/2	0.24	17/32	9/16	15/16
▲ 1	0.49	5/8	25/32	1 1/4

Visit our website for the most current information.

ELBOWS *continued*

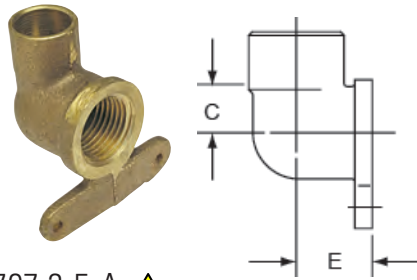

707-3-5-A ⚠
90° Hy-Set Elbow C x F – Cast

NOM. SIZE	APPROX. NET WT./LBS.	DIM. C INCHES	DIM. E INCHES
▲ 1/2	0.20	9/16	27/32

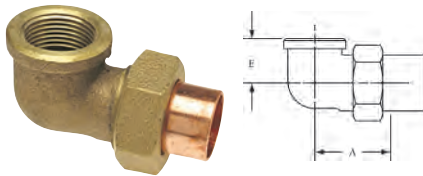

707-3-6 ⚠
90° Union Elbow C x F – Cast

NOM. SIZE	APPROX. NET WT./LBS.	DIM. A INCHES	DIM. E INCHES
▲ 1/2	0.31	1 1/16	7/8
▲ 3/4	0.48	1 11/32	1
1	0.77	1 1/2	1 1/4

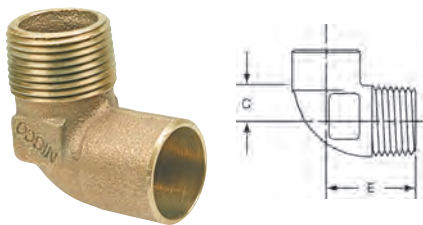

707-4 ⚠
90° Elbow C x M – Cast

NOM. SIZE	APPROX. NET WT./LBS.	DIM. C INCHES	DIM. E INCHES
▲ 3/8	0.08	5/16	7/8
▲ 1/2	0.14	7/16	1 9/32
1/2 x 3/8	0.10	5/16	15/16
▲ 1/2 x 3/4	0.19	9/16	1 5/32
▲ 3/4	0.19	1/2	1 1/4
▲ 3/4 x 1/2	0.18	7/16	1 5/16
3/4 x 1	0.33	2 1/32	1 13/32
▲ 1	0.43	2 3/32	1 5/8
▲ 1 1/4	0.55	7/8	2
▲ 1 1/2	0.81	1	2 3/16
▲ 2	1.38	1 11/16	2 9/32

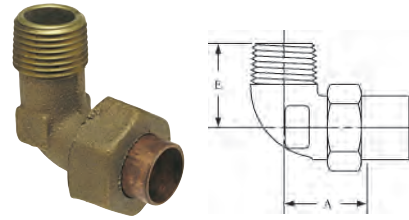

707-4-6 ⚠
90° Union Elbow C x M – Cast

NOM. SIZE	APPROX. NET WT./LBS.	DIM. A INCHES	DIM. E INCHES
▲ 3/8	0.20	15/16	1 3/16
▲ 1/2	0.30	15/16	1 1/2
▲ 3/4	0.49	1 7/32	1 13/16
1	0.71	1 11/32	1 5/8
1 1/4	1.09	1 21/32	1 11/16

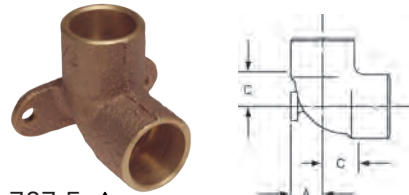

707-5 ⚠
90° Drop Elbow C x C – Cast

NOM. SIZE	APPROX. NET WT./LBS.	DIM. A INCHES	DIM. C INCHES
▲ 1/2	0.13	13/32	7/16
▲ 3/4	0.17	15/32	9/16

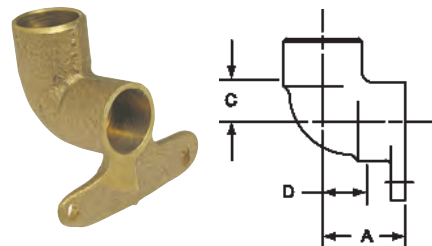

707-5-A ⚠
90° Hy-Set Elbow C x C – Cast

NOM. SIZE	APPROX. NET WT./LBS.	DIM. A INCHES	DIM. C INCHES	DIM. D INCHES
▲ 1/2	0.13	15/16	7/16	7/16
▲ 3/4	0.21	1 5/16	9/16	9/16

⚠ WARNING: This product can expose you to chemicals including lead, which is known to the State of California to cause cancer and birth defects or other reproductive harm. For more information go to www.P65Warnings.ca.gov.

▲ Also available in Lead-Free*. For additional details, see our Lead-Free* literature on www.nibco.com.

*Weighted average lead content ≤ 0.25%

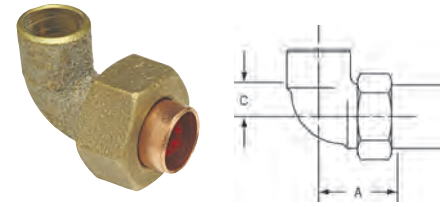

707-6 ⚠
90° Union Elbow C x C – Cast

NOM. SIZE	APPROX. NET WT./LBS.	DIM. A INCHES	DIM. C INCHES
▲ 3/8	0.17	13/16	5/16
▲ 1/2	0.25	15/16	7/16
▲ 3/4	0.39	1 17/32	9/16
1	0.64	1 21/32	2 3/32
1 1/4	0.94	1 19/32	2 3/32

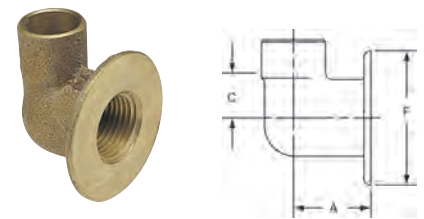

708 ⚠
90° Flanged Sink Elbow C x F – Cast

NOM. SIZE	APPROX. NET WT./LBS.	DIM. A INCHES	DIM. C INCHES	DIM. F INCHES
▲ 1/2	0.21	7/8	9/16	1 3/4

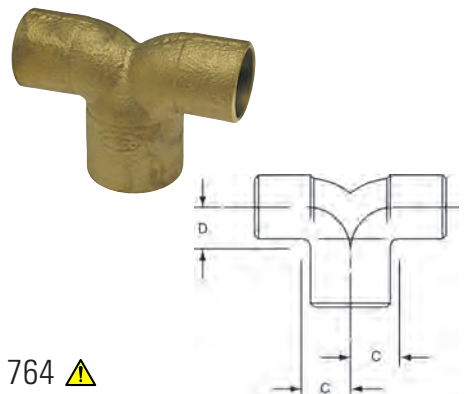

764 ⚠
90° Double Elbow C x C x C – Cast

NOM. SIZE	APPROX. NET WT./LBS.	DIM. C INCHES	DIM. D INCHES
1 x 3/4 x 3/4	0.33	3/4	2 1/32

Consult price sheet for Made to Order items and for minimum order quantities.

Visit our website for the most current information.

FITTING REDUCERS

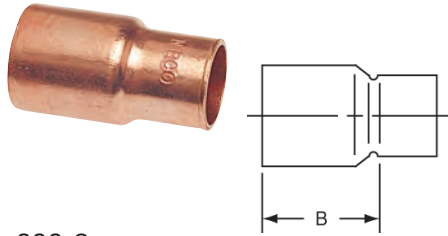

600-2
Fitting Reducer Ftg x C – Wrot

NOM. SIZE	APPROX. NET WT./LBS.	DIM. B INCHES
1/4 x 1/8	0.01	17/32
3/8 x 1/8	0.01	23/32
3/8 x 1/4	0.01	19/32
1/2 x 1/4	0.02	27/32
1/2 x 3/8	0.02	11/16
5/8 x 1/4	0.03	11/32
5/8 x 3/8	0.04	31/32
5/8 x 1/2	0.05	7/8
3/4 x 1/4	0.05	13/32
3/4 x 3/8	0.05	11/8
3/4 x 1/2	0.06	11/8
3/4 x 5/8	0.06	15/16
1 x 3/8	0.08	19/32
1 x 1/2	0.09	11/4
1 x 5/8	0.09	13/8
1 x 3/4	0.10	17/32
1 1/4 x 1/2	0.13	13/8
1 1/4 x 3/4	0.16	11/2
1 1/4 x 1	0.15	15/16
1 1/2 x 1/2	0.16	119/32
1 1/2 x 3/4	0.20	117/32
1 1/2 x 1	0.21	15/8
1 1/2 x 1 1/4	0.23	113/32
2 x 1/2	0.34	115/16
2 x 3/4	0.34	127/32
2 x 1	0.35	127/32
2 x 1 1/4	0.34	23/32
2 x 1 1/2	0.39	131/32
2 1/2 x 1	0.51	29/32
2 1/2 x 1 1/4	0.50	29/32
2 1/2 x 1 1/2	0.59	23/8
2 1/2 x 2	0.65	131/32
3 x 1 1/4	0.77	31/4
3 x 1 1/2	0.81	219/32
3 x 2	0.99	29/16
3 x 2 1/2	1.03	21/4
3 1/2 x 3	1.48	211/32

Continues...

Consult price sheet for Made to Order items and for minimum order quantities.

Visit our website for the most current information.

NOM. SIZE	APPROX. NET WT./LBS.	DIM. B INCHES
4 x 2	1.64	31/8
4 x 2 1/2	1.83	31/32
4 x 3	2.00	31/32
4 x 3 1/2	2.09	25/8
5 x 2	2.73	411/16
5 x 2 1/2	2.75	419/32
5 x 3	2.76	45/16
5 x 4	3.08	313/16
6 x 2	4.20	523/32
6 x 2 1/2	4.32	55/8
6 x 3	4.38	57/16
6 x 4	4.68	415/16
6 x 5	5.12	415/32
8 x 2	12.12	77/16
8 x 2 1/2	11.42	73/16
8 x 3	10.64	615/16
8 x 4	11.11	67/16
8 x 5	10.35	515/16
8 x 6	11.33	515/32

FLANGES – CLASS 125

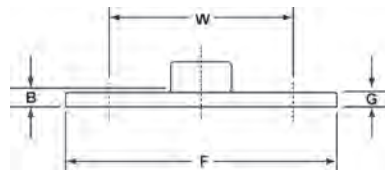

741 ⚠
Companion Flange C – Cast

NOM. SIZE	APPROX. NET WT./LBS.	DIM. B INCHES	DIM. F INCHES	DIM. G INCHES	DIM. W INCHES
1/2	0.56	1/8	31/2	7/32	23/8
3/4	0.71	1/8	37/8	7/32	23/4
1	1.27	1/8	41/4	1/4	31/8
1 1/4	1.42	1/8	45/8	1/4	31/2
1 1/2	1.82	1/8	5	5/16	37/8
2	2.76	1/8	6	3/8	43/4
2 1/2	4.29	1/8	7	3/8	51/2
3	5.26	1/8	71/2	7/16	6
4	7.35	1/8	9	7/16	71/2
5	9.04	1/8	10	7/16	81/2
6	12.68	1/8	11	1/2	91/2

NOTE: Dim. B = Tube Stop to Flange Face

⚠ WARNING: This product can expose you to chemicals including lead, which is known to the State of California to cause cancer and birth defects or other reproductive harm. For more information go to www.P65Warnings.ca.gov.

FLANGES – CLASS 150

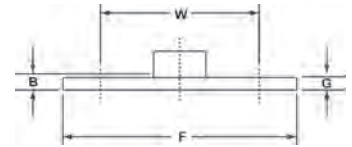

771 ⚠
Companion Flange C – Cast

NOM. SIZE	APPROX. NET WT./LBS.	DIM. B INCHES	DIM. F INCHES	DIM. G INCHES	DIM. W INCHES
3/4	1.15	1/8	37/8	11/32	23/4
▲ 1	1.59	1/8	41/4	3/8	31/8
▲ 1 1/4	1.91	1/8	45/8	13/32	31/2
▲ 1 1/2	2.57	1/8	5	7/16	37/8
▲ 2	4.10	1/8	6	1/2	43/4
▲ 2 1/2	6.34	1/8	7	9/16	51/2
▲ 3	8.31	1/8	71/2	5/8	6
▲ 4	11.85	1/8	9	11/16	71/2
▲ 5	15.69	1/8	10	3/4	81/2
▲ 6	19.12	1/8	11	13/16	91/2

NOTE: Dim. B = Tube Stop to Flange Face

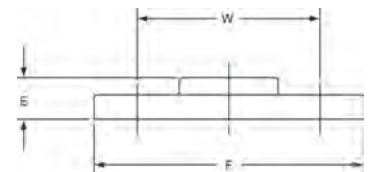

775 ⚠
Threaded Companion Flange F – Cast

NOM. SIZE	APPROX. NET WT./LBS.	DIM. E INCHES	DIM. F INCHES	DIM. W INCHES
▲ 2	4.13	1	6	43/4
▲ 2 1/2	6.43	13/16	7	51/2
▲ 3	7.13	13/16	71/2	6
▲ 4	11.47	15/16	9	71/2

▲ Also available in Lead-Free*. For additional details, see our Lead-Free* literature on www.nibco.com.

*Weighted average lead content ≤ 0.25%

PLUGS

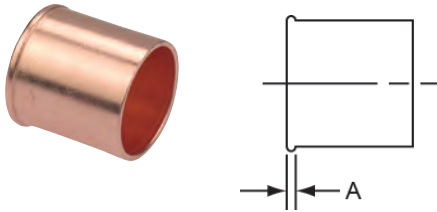

616
Fitted Plug Ftg - Wrot

NOM. SIZE	APPROX. NET WT./LBS.	DIM. A INCHES
3/8	0.012	1/16
1/2	0.02	3/32
3/4	0.05	5/32

RETURN BENDS

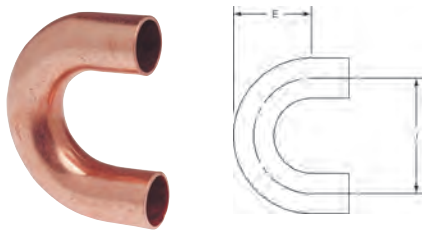

638
Return Bend C x C – Wrot

NOM. SIZE	APPROX. NET WT./LBS.	DIM. E INCHES	DIM. J INCHES
1/8	0.02	2 ¹ / ₃₂	1
1/4	0.04	3 ¹ / ₃₂	1 ¹ / ₄
3/8	0.08	1 ¹ / ₃₂	1 ¹ / ₂
1/2	0.13	1 ¹ / ₂	2
3/4	0.26	1 ¹⁹ / ₃₂	2 ¹ / ₂
1	0.44	2 ³ / ₃₂	3
1 1/4	0.70	2 ¹³ / ₁₆	4
1 1/2	1.04	3 ⁵ / ₃₂	4 ¹ / ₂
2	1.92	3 ²⁹ / ₃₂	5 ¹ / ₂

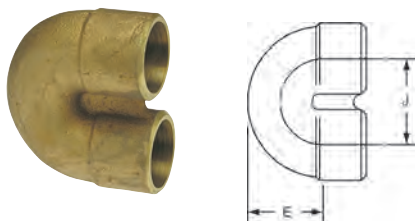

739 ⚠
Return Bend – Closed
C x C – Cast

NOM. SIZE	APPROX. NET WT./LBS.	DIM. E INCHES	DIM. J INCHES
3/4	0.29	1 ⁵ / ₃₂	1 ⁵ / ₁₆

STRAPS & HANGERS

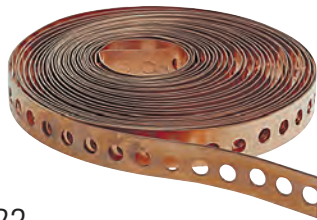

623
Copper Hanger Strap

SIZE	APPROX. NET WT./LBS.
3/4" Wide x 25 Ft. Roll	1.93



624
Tube Strap

NOM. SIZE	APPROX. NET WT./LBS.
1/8	0.01
1/4	0.01
3/8	0.01
1/2	0.02
5/8	0.02
3/4	0.02
1	0.02
1 1/4	0.03
1 1/2	0.03
2	0.04

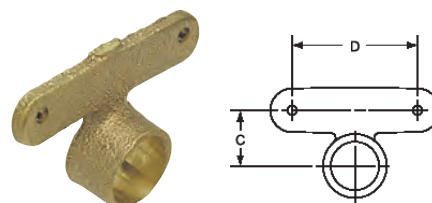

724-5-A ⚠
Hy-Set Hanger
C – Cast

NOM. SIZE	APPROX. NET WT./LBS.	DIM. C INCHES	DIM. D INCHES
1/2	0.05	2 ³ / ₃₂	1 ⁵ / ₈
3/4	0.09	2 ⁷ / ₃₂	1 ⁵ / ₈
1	0.13	1	1 ⁵ / ₈

TEES

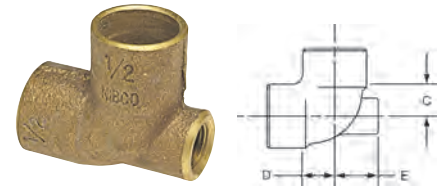

705 ⚠
Baseboard Tee C x F x C – Cast

NOM. SIZE	APPROX. NET WT. LBS.	DIMENSIONS INCHES		
		C	D	E
1/2 x 1/8 x 3/4	0.15	7/16	9/16	11/16
▲ 1/2 x 1/8 x 1/2	0.08	1/2	1/2	9/16
3/4 x 1/8 x 1	0.30	5/8	3/4	13/16
▲ 3/4 x 1/8 x 3/4	0.19	9/16	9/16	11/16
▲ 1 x 1/8 x 1	0.32	2 ³ / ₃₂	2 ³ / ₃₂	9/16
▲ 1 1/4 x 1/8 x 1 1/4	0.51	7/8	7/8	15/16

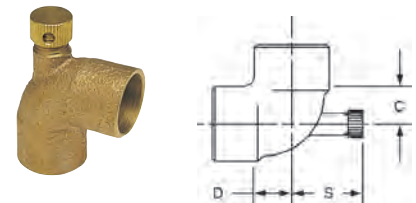

705-D ⚠
Vent Elbow C x C – Cast

NOM. SIZE	APPROX. NET WT. LBS.	DIMENSIONS INCHES		
		C	D	S
▲ 1/2	0.09	1/2	1/2	3/4
▲ 3/4	0.20	9/16	9/16	13/16
▲ 1	0.31	2 ³ / ₃₂	2 ³ / ₃₂	15/16

⚠ WARNING: This product can expose you to chemicals including lead, which is known to the State of California to cause cancer and birth defects or other reproductive harm. For more information go to www.P65Warnings.ca.gov.

▲ Also available in Lead-Free*. For additional details, see our Lead-Free* literature on www.nibco.com.

*Weighted average lead content ≤ 0.25%

Consult price sheet for Made to Order items and for minimum order quantities.

Visit our website for the most current information.

TEES *continued*

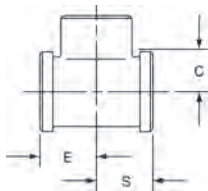

710-3 ▲ Tee F x F x C – Cast

NOM. SIZE	APPROX. NET WT. LBS.	DIMENSIONS INCHES		
		C	E	S
1/2	0.20	9/16	7/8	7/8
▲ 3/4	0.37	11/16	1	1
▲ 3/4 x 1/2 x 1/2	0.20	9/16	7/8	31/32
▲ 3/4 x 1/2 x 3/4	0.21	9/16	15/16	1
▲ 3/4 x 3/4 x 1/2	0.31	11/16	31/32	31/32

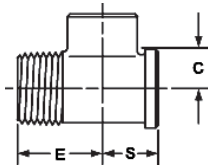

710-3-4 ▲ Tee M x F x C – Cast

NOM. SIZE	APPROX. NET WT. LBS.	DIMENSIONS INCHES		
		C	E	S
▲ 3/4	0.32	11/16	111/32	1
3/4 x 3/4 x 1/2	0.33	5/8	115/16	19/16

WARNING: This product can expose you to chemicals including lead, which is known to the State of California to cause cancer and birth defects or other reproductive harm. For more information go to www.P65Warnings.ca.gov.

▲ Also available in Lead-Free*. For additional details, see our Lead-Free* literature on www.nibco.com.

*Weighted average lead content ≤ 0.25%

Consult price sheet for Made to Order items and for minimum order quantities.

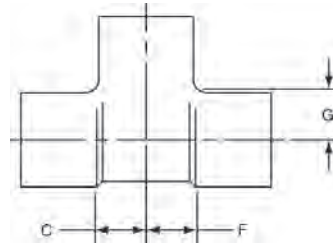

611 Tee C x C x C – Wrot

NOM. SIZE	APPROX. NET WT. LBS.	DIMENSIONS INCHES		
		C	F	G
3/16 _{O.D.}	0.01	7/32	7/32	7/32
1/8	0.02	5/16	5/16	1/4
1/8 x 1/8 x 1/4	0.02	13/32	13/32	9/32
1/8 x 1/8 x 3/16 _{O.D.}	0.01	5/16	5/16	5/16
1/8 x 3/16 _{O.D.} x 1/8	0.01	5/16	11/32	1/4
5/16 _{O.D.}	0.02	3/8	3/8	5/16
5/16 _{O.D.} x 1/8 x 1/8	0.02	3/8	13/32	11/32
5/16 _{O.D.} x 1/8 x 5/16 _{O.D.}	0.02	3/8	13/32	5/16
5/16 _{O.D.} x 5/16 _{O.D.} x 1/8	0.03	3/8	3/8	5/16
5/16 _{O.D.} x 5/16 _{O.D.} x 1/4	0.02	3/8	3/8	9/32
1/4	0.02	5/16	5/16	1/4
1/4 x 1/8 x 1/8	0.02	5/16	13/32	11/32
1/4 x 1/8 x 1/4	0.02	5/16	13/32	9/32
1/4 x 5/16 _{O.D.} x 1/4	0.02	5/16	3/8	9/32
1/4 x 1/4 x 1/8	0.03	5/16	5/16	5/16
1/4 x 1/4 x 3/8	0.04	17/32	17/32	11/32
1/4 x 1/4 x 1/2	0.07	19/32	19/32	3/8
1/4 x 1/4 x 3/16 _{O.D.}	0.02	5/16	5/16	7/16
1/4 x 1/4 x 5/16 _{O.D.}	0.02	5/16	5/16	5/16
3/8	0.04	11/32	11/32	11/32
3/8 x 1/8 x 1/8	0.04	11/32	19/32	19/32
3/8 x 1/8 x 3/8	0.04	11/32	19/32	11/32
3/8 x 1/4 x 1/8	0.04	11/32	17/32	9/16
3/8 x 1/4 x 1/4	0.04	11/32	17/32	15/32
3/8 x 1/4 x 3/8	0.04	11/32	17/32	11/32
3/8 x 3/8 x 1/8	0.04	11/32	11/32	9/16
3/8 x 3/8 x 5/16 _{O.D.}	0.04	11/32	11/32	15/32
3/8 x 3/8 x 1/4	0.04	11/32	11/32	15/32
3/8 x 3/8 x 1/2	0.05	1/2	1/2	3/8
1/2	0.06	11/32	11/32	11/32
1/2 x 1/4 x 1/4	0.06	11/32	19/32	17/32
1/2 x 1/4 x 3/8	0.06	5/16	5/8	13/32
1/2 x 3/8 x 1/4	0.06	5/16	17/32	9/16
1/2 x 3/8 x 3/8	0.06	5/16	17/32	13/32
1/2 x 3/8 x 1/2	0.07	7/16	17/32	3/8
1/2 x 1/2 x 1/8	0.07	5/16	5/16	3/4
1/2 x 1/2 x 1/4	0.06	5/16	5/16	9/16
1/2 x 1/2 x 3/8	0.07	5/16	5/16	13/32
1/2 x 1/2 x 5/8	0.11	5/8	5/8	7/16
1/2 x 1/2 x 3/4	0.12	17/32	17/32	11/32
1/2 x 1/2 x 1	0.29	1	1	21/32

NOTE: Tee sizes are read Run x Run x Outlet.

NOM. SIZE	APPROX. NET WT. LBS.	DIMENSIONS INCHES		
		C	F	G
5/8	0.12	7/16	7/16	7/16
5/8 x 3/8 x 3/8	0.11	7/16	3/4	5/8
5/8 x 3/8 x 5/8	0.10	7/16	3/4	7/16
5/8 x 1/2 x 1/2	0.11	7/16	19/32	13/32
5/8 x 1/2 x 5/8	0.10	7/16	5/8	7/16
5/8 x 5/8 x 1/4	0.11	7/16	7/16	3/4
5/8 x 5/8 x 3/8	0.09	7/16	7/16	5/8
5/8 x 5/8 x 1/2	0.11	7/16	7/16	13/32
5/8 x 5/8 x 3/4	0.15	23/32	23/32	1/2
3/4	0.16	7/16	7/16	7/16
3/4 x 3/8 x 3/8	0.12	7/16	23/32	21/32
3/4 x 3/8 x 1/2	0.12	7/16	23/32	17/32
3/4 x 3/8 x 3/4	0.15	17/32	27/32	1/2
3/4 x 1/2 x 1/4	0.12	13/32	9/16	25/32
3/4 x 1/2 x 3/8	0.12	7/16	21/32	21/32
3/4 x 1/2 x 1/2	0.14	13/32	19/32	1/2
3/4 x 1/2 x 3/4	0.16	7/16	11/16	7/16
3/4 x 5/8 x 5/8	0.15	1/2	3/4	11/16
3/4 x 5/8 x 3/4	0.15	17/32	11/16	1/2
3/4 x 3/4 x 1/8	0.12	7/16	7/16	13/16
3/4 x 3/4 x 1/4	0.12	13/32	13/32	25/32
3/4 x 3/4 x 3/8	0.12	13/32	13/32	21/32
3/4 x 3/4 x 1/2	0.14	3/8	3/8	15/32
3/4 x 3/4 x 5/8	0.16	17/32	17/32	11/16
3/4 x 3/4 x 1	0.22	23/32	23/32	1/2
7/8	0.30	23/32	23/32	23/32
1	0.31	11/16	11/16	21/32
1 x 1/2 x 1/2	0.22	1/2	25/32	11/16
1 x 1/2 x 3/4	0.24	9/16	7/8	11/16
1 x 1/2 x 1	0.30	11/16	11/32	21/32
1 x 3/4 x 1/2	0.22	15/32	11/16	11/16
1 x 3/4 x 3/4	0.24	9/16	25/32	23/32
1 x 3/4 x 1	0.31	11/16	31/32	21/32
1 x 1 x 1/4	0.22	1/2	1/2	13/16
1 x 1 x 3/8	0.22	1/2	1/2	29/32
1 x 1 x 1/2	0.23	1/2	1/2	11/16
1 x 1 x 5/8	0.24	19/32	19/32	29/32
1 x 1 x 3/4	0.25	19/32	19/32	23/32
1 x 1 x 1/4	0.42	15/32	15/32	7/8
1 x 1 x 1/2	0.59	111/32	111/32	31/32

Continues...

Continues...

Visit our website for the most current information.

TEES *continued*

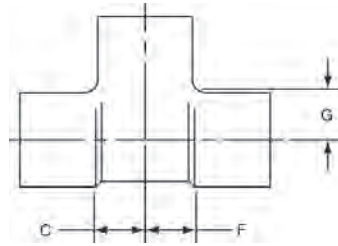

611
Tee C x C x C – Wrot continued

NOM. SIZE	APPROX. NET WT. LBS.	C	F	G
1 1/4	0.43	13/16	13/16	13/16
1 1/4 x 1/2 x 1 1/4	0.42	13/16	17/32	13/16
1 1/4 x 3/4 x 1/2	0.31	15/32	3/4	25/32
1 1/4 x 3/4 x 3/4	0.36	21/32	15/16	3/4
1 1/4 x 3/4 x 1	0.45	25/32	11/16	29/32
1 1/4 x 3/4 x 1 1/4	0.41	13/16	11/8	13/16
1 1/4 x 1 x 1/2	0.31	15/32	19/32	13/16
1 1/4 x 1 x 3/4	0.37	21/32	13/16	25/32
1 1/4 x 1 x 1	0.47	25/32	31/32	29/32
1 1/4 x 1 x 1 1/4	0.41	13/16	11/32	13/16
1 1/4 x 1 1/4 x 3/8	0.30	15/32	15/32	29/32
1 1/4 x 1 1/4 x 1/2	0.31	15/32	15/32	25/32
1 1/4 x 1 1/4 x 3/4	0.39	21/32	21/32	3/4
1 1/4 x 1 1/4 x 1	0.45	25/32	25/32	27/32
1 1/4 x 1 1/4 x 1 1/2	0.57	13/16	13/16	29/32
1 1/4 x 1 1/4 x 2	1.04	115/16	115/16	11/4
1 1/2	0.62	15/16	15/16	15/16
1 1/2 x 1/2 x 1 1/2	0.60	11/32	113/32	31/32
1 1/2 x 3/4 x 1/2	0.39	1/2	29/32	11/32
1 1/2 x 3/4 x 3/4	0.47	19/32	13/32	29/32
1 1/2 x 3/4 x 1	0.54	25/32	11/4	11/32
1 1/2 x 3/4 x 1 1/4	0.60	29/32	111/32	11/16
1 1/2 x 3/4 x 1 1/2	0.59	15/16	13/8	15/16
1 1/2 x 1 x 1/2	0.39	1/2	25/32	11/32
1 1/2 x 1 x 3/4	0.46	5/8	31/32	15/16
1 1/2 x 1 x 1	0.54	3/4	11/16	31/32
1 1/2 x 1 x 1 1/4	0.60	29/32	11/8	11/16
1 1/2 x 1 x 1 1/2	0.60	11/32	111/32	29/32
1 1/2 x 1 1/4 x 1/2	0.41	1/2	25/32	11/32
1 1/2 x 1 1/4 x 3/4	0.46	19/32	29/32	15/16
1 1/2 x 1 1/4 x 1	0.54	25/32	1	11/32
1 1/2 x 1 1/4 x 1 1/4	0.59	31/32	13/32	31/32
1 1/2 x 1 1/4 x 1 1/2	0.60	11/32	13/16	29/32
1 1/2 x 1 1/2 x 1/2	0.40	1/2	1/2	1
1 1/2 x 1 1/2 x 3/4	0.48	19/32	19/32	15/16
1 1/2 x 1 1/2 x 1	0.55	3/4	3/4	15/16
1 1/2 x 1 1/2 x 1 1/4	0.61	29/32	29/32	1
1 1/2 x 1 1/2 x 2	1.05	125/32	125/32	11/4

Continues...

NOM. SIZE	APPROX. NET WT. LBS.	C	F	G
2	1.11	19/32	19/32	11/32
2 x 1/2 x 2	1.09	19/32	23/8	11/4
2 x 3/4 x 2	1.07	19/32	23/16	11/4
2 x 1 x 1	0.91	27/32	119/32	111/32
2 x 1 x 2	1.06	11/8	125/32	11/4
2 x 1 1/4 x 3/4	1.04	11/4	131/32	23/32
2 x 1 1/4 x 1	0.90	27/32	19/32	123/64
2 x 1 1/4 x 1 1/4	0.96	11/8	117/32	15/16
2 x 1 1/4 x 1 1/2	1.04	13/32	17/32	13/8
2 x 1 1/4 x 2	1.08	19/32	131/32	11/32
2 x 1 1/2 x 1/2	0.79	11/16	29/32	15/16
2 x 1 1/2 x 3/4	1.04	11/4	123/32	23/32
2 x 1 1/2 x 1	0.91	29/32	11/8	17/32
2 x 1 1/2 x 1 1/4	1.07	11/8	13/8	15/16
2 x 1 1/2 x 1 1/2	1.06	13/32	115/32	111/32
2 x 1 1/2 x 2	1.07	19/32	125/32	11/32
2 x 2 x 1/2	0.77	19/32	19/32	15/16
2 x 2 x 3/4	0.66	7/16	7/16	11/4
2 x 2 x 1	0.91	27/32	27/32	11/4
2 x 2 x 1 1/4	1.01	11/8	11/8	15/16
2 x 2 x 1 1/2	1.07	13/32	13/32	13/8
2 x 2 x 2 1/2	2.11	23/16	23/16	17/8
2 1/2	2.08	19/16	19/16	17/8
2 1/2 x 3/4 x 2 1/2	2.16	19/16	215/16	17/8
2 1/2 x 1 x 2 1/2	2.22	19/16	29/16	17/8
2 1/2 x 1 1/4 x 2	2.26	19/16	25/8	23/16
2 1/2 x 1 1/4 x 2 1/2	2.20	19/16	217/32	15/8
2 1/2 x 1 1/2 x 2 1/2	2.20	19/16	217/32	17/8
2 1/2 x 2 x 3/4	1.34	11/8	11/16	17/8
2 1/2 x 2 x 1	1.34	13/16	13/16	111/16
2 1/2 x 2 x 1 1/4	1.62	125/32	113/32	127/32
2 1/2 x 2 x 1 1/2	1.61	121/32	11/2	111/16
2 1/2 x 2 x 2	1.72	113/16	113/32	125/32
2 1/2 x 2 x 2 1/2	2.20	19/16	23/16	17/8
2 1/2 x 2 1/2 x 1/2	1.30	25/32	25/32	21/8
2 1/2 x 2 1/2 x 3/4	1.28	25/32	25/32	113/16
2 1/2 x 2 1/2 x 1	1.26	5/8	5/8	15/8
2 1/2 x 2 1/2 x 1 1/4	1.58	111/32	111/32	127/32
2 1/2 x 2 1/2 x 1 1/2	1.58	13/8	13/8	127/32
2 1/2 x 2 1/2 x 2	1.70	113/32	113/32	119/32

Continues...

NOTE: Tee sizes are read Run x Run x Outlet.

NOM. SIZE	APPROX. NET WT. LBS.	C	F	G
3	3.12	17/8	17/8	21/32
3 x 3/4 x 3	3.28	113/16	31/4	23/16
3 x 1 x 3	3.34	113/16	31/4	23/16
3 x 1 1/4 x 3	3.28	113/16	27/8	23/16
3 x 1 1/2 x 3	3.31	113/16	229/32	23/16
3 x 2 x 2	2.34	115/32	131/32	131/32
3 x 2 x 2 1/2	3.18	113/16	225/32	21/2
3 x 2 x 3	3.31	113/16	221/32	23/16
3 x 2 1/2 x 1	3.08	113/16	215/32	31/4
3 x 2 1/2 x 1 1/4	3.07	113/16	215/32	229/32
3 x 2 1/2 x 2	2.34	115/32	127/32	131/32
3 x 2 1/2 x 2 1/2	3.21	113/16	215/32	21/2
3 x 2 1/2 x 3	3.35	113/16	215/32	23/16
3 x 3 x 1/2	1.94	27/32	27/32	23/8
3 x 3 x 3/4	1.94	27/32	27/32	23/16
3 x 3 x 1	1.88	27/32	27/32	115/16
3 x 3 x 1 1/4	2.44	115/32	115/32	27/16
3 x 3 x 1 1/2	2.40	115/32	115/32	29/32
3 x 3 x 2	2.32	115/32	115/32	131/32
3 x 3 x 2 1/2	3.34	113/16	113/16	21/2
3 1/2	6.57	217/32	217/32	217/32
4	7.89	213/32	213/32	217/32
4 x 1 x 4	7.58	23/8	41/4	223/32
4 x 2 x 2	7.62	23/8	4	315/16
4 x 2 x 4	7.86	23/8	4	223/32
4 x 2 1/2 x 2 1/2	7.52	23/8	325/32	329/32
4 x 2 1/2 x 4	7.84	23/8	325/32	223/32
4 x 3 x 2	7.50	23/8	39/16	315/16
4 x 3 x 2 1/2	7.42	23/8	39/16	329/32
4 x 3 x 3	7.43	23/8	39/16	31/2
4 x 3 x 4	7.76	23/8	323/32	223/32
4 x 4 x 1/2	4.42	13/32	13/32	27/8
4 x 4 x 3/4	4.17	13/32	13/32	229/32
4 x 4 x 1	4.45	31/32	31/32	29/16
4 x 4 x 1 1/4	4.60	111/32	111/32	27/8
4 x 4 x 1 1/2	4.50	19/32	19/32	23/4
4 x 4 x 2	4.98	111/32	111/32	27/16
4 x 4 x 2 1/2	7.78	23/8	23/8	329/32
4 x 4 x 3	7.77	23/8	23/8	31/2

Continued on next page.

Consult price sheet for Made to Order items and for minimum order quantities.

Visit our website for the most current information.

TEES *continued*

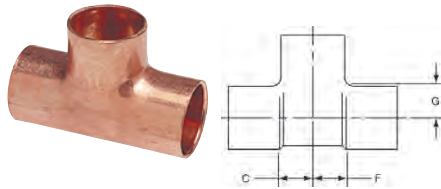

611
Tee C x C x C – Wrot continued

NOM. SIZE	APPROX. NET WT. LBS.	DIMENSIONS INCHES		
		C	F	G
5	8.29	2 ²⁷ / ₃₂	2 ²⁷ / ₃₂	3 ¹³ / ₃₂
5 x 2 x 5	9.47	2 ²⁷ / ₃₂	5 ²⁹ / ₃₂	3 ¹³ / ₃₂
5 x 4 x 4	8.18	2 ¹ / ₄	4 ¹⁷ / ₃₂	3 ¹ / ₈
5 x 4 x 5	8.58	2 ²⁷ / ₃₂	4 ²⁹ / ₃₂	3 ¹³ / ₃₂
5 x 5 x 1	4.20	2 ³ / ₃₂	2 ³ / ₃₂	3 ³ / ₁₆
5 x 5 x 1 1/4	4.76	1 ⁷ / ₃₂	1 ⁷ / ₃₂	3 ³ / ₁₆
5 x 5 x 1 1/2	4.88	1 ¹ / ₃₂	1 ¹ / ₃₂	3 ³ / ₁₆
5 x 5 x 2	5.30	1 ⁹ / ₃₂	1 ⁹ / ₃₂	3 ³ / ₁₆
5 x 5 x 2 1/2	5.91	1 ⁵ / ₈	1 ⁵ / ₈	3 ³ / ₁₆
5 x 5 x 3	5.91	1 ²⁵ / ₃₂	1 ²⁵ / ₃₂	3 ³ / ₁₆
5 x 5 x 4	7.10	2 ⁹ / ₃₂	2 ⁹ / ₃₂	3 ³ / ₁₆
6	13.50	3 ⁹ / ₃₂	3 ⁹ / ₃₂	4 ¹ / ₃₂
6 x 4 x 1 1/2	9.62	1 ³ / ₁₆	3 ²⁷ / ₃₂	3 ¹¹ / ₁₆
6 x 4 x 4	11.37	2 ⁹ / ₃₂	5 ³ / ₃₂	3 ¹¹ / ₁₆
6 x 4 x 6	16.60	3 ⁹ / ₃₂	6 ⁵ / ₃₂	4 ¹ / ₃₂
6 x 6 x 1/2	7.17	1 ⁵ / ₁₆	1 ⁵ / ₁₆	4 ¹¹ / ₁₆
6 x 6 x 3/4	7.19	1 ⁵ / ₁₆	1 ⁵ / ₁₆	4 ²¹ / ₃₂
6 x 6 x 1	7.18	1 ⁵ / ₁₆	1 ⁵ / ₁₆	3 ¹¹ / ₁₆
6 x 6 x 1 1/4	6.67	2 ⁹ / ₃₂	2 ⁹ / ₃₂	3 ¹¹ / ₁₆
6 x 6 x 1 1/2	6.87	1	1	3 ¹¹ / ₁₆
6 x 6 x 2	7.78	1 ⁹ / ₃₂	1 ⁹ / ₃₂	3 ¹¹ / ₁₆
6 x 6 x 2 1/2	8.12	1 ¹⁷ / ₃₂	1 ¹⁷ / ₃₂	3 ³ / ₄
6 x 6 x 3	8.92	1 ²⁵ / ₃₂	1 ²⁵ / ₃₂	3 ¹¹ / ₁₆
6 x 6 x 4	10.17	2 ⁹ / ₃₂	2 ⁹ / ₃₂	3 ¹¹ / ₁₆
6 x 6 x 5	11.67	2 ²⁵ / ₃₂	2 ²⁵ / ₃₂	4 ¹ / ₃₂
8	36.81	4 ¹⁷ / ₃₂	4 ¹⁷ / ₃₂	5 ¹ / ₃₂
8 x 8 x 2	18.02	1 ⁹ / ₃₂	1 ⁹ / ₃₂	4 ³ / ₄
8 x 8 x 2 1/2	19.02	1 ¹⁷ / ₃₂	1 ¹⁷ / ₃₂	4 ³ / ₄
8 x 8 x 3	20.02	1 ²⁵ / ₃₂	1 ²⁵ / ₃₂	4 ³ / ₄
8 x 8 x 4	22.26	2 ⁹ / ₃₂	2 ⁹ / ₃₂	4 ¹ / ₂
8 x 8 x 5	24.90	2 ²⁵ / ₃₂	2 ²⁵ / ₃₂	4 ¹⁵ / ₁₆
8 x 8 x 6	27.86	3 ⁹ / ₃₂	3 ⁹ / ₃₂	5 ¹ / ₈

NOTE: Tee sizes are read Run x Run x Outlet.

Consult price sheet for Made to Order items and for minimum order quantities.

Visit our website for the most current information.

611-HE
Heat Exchanger Tee
C x C x C – Wrot

Tube slips entirely through fitting on small end of run. Sizes same as listed under 611 where tee has one or more reductions on one end of run.

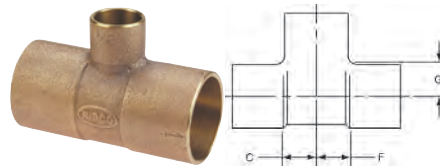

711 ⚠️
Tee C x C x C – Cast

NOM. SIZE	APPROX. NET WT. LBS.	DIMENSIONS INCHES		
		C	F	G
1 1/4 x 1/2 x 1/2	0.50	5/8	2 ⁷ / ₃₂	1/2
▲ 1 1/4 x 1/2 x 1	0.48	3/4	3/4	3/8
1 1/2 x 1/2 x 1 1/4	0.70	7/8	3 ¹ / ₃₂	1/2
2 x 3/4 x 3/4	0.82	2 ¹ / ₃₂	7/8	1/2
2 x 1 x 1 1/2	1.23	1	1 ¹ / ₄	5/8
2 x 2 x 3	3.11	1 ²¹ / ₃₂	1 ²¹ / ₃₂	1 ³ / ₁₆
2 1/2 x 1/2 x 2 1/2	2.46	1 ¹ / ₂	2 ⁷ / ₃₂	1/2
2 1/2 x 1 1/2 x 1 1/2	1.76	1	1 ⁷ / ₃₂	7/8
2 1/2 x 1 1/2 x 2	2.02	1 ¹ / ₄	1 ¹⁵ / ₃₂	7/8
2 1/2 x 2 1/2 x 3	2.98	1 ³ / ₄	1 ³ / ₄	1 ¹³ / ₃₂
3 x 2 x 1 1/2	2.63	1	1 ¹ / ₄	1 ⁵ / ₃₂
3 x 2 1/2 x 1 1/2	2.53	1	1 ³ / ₃₂	1 ¹³ / ₃₂
3 x 3 x 4	6.96	2 ¹¹ / ₃₂	2 ¹¹ / ₃₂	2 ²³ / ₃₂
4 x 2 x 2	4.64	1 ¹ / ₄	1 ³ / ₄	2 ⁵ / ₃₂

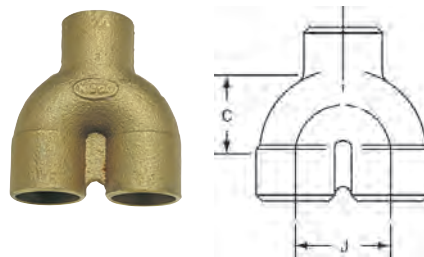

711-A ⚠️
Supply and Return Tee
C x C x C – Cast

NOM. SIZE	APPROX. NET WT. LBS.	DIMENSIONS INCHES	
		C	J
1/2	0.17	1 ³ / ₁₆	1

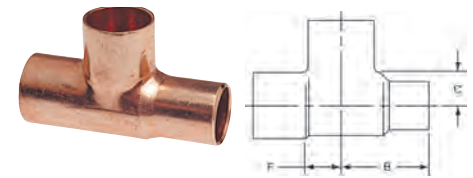

611-2
Fitting Tee C x Ftg x C – Wrot

NOM. SIZE	APPROX. NET WT. LBS.	DIMENSIONS INCHES		
		B	C	F
1/2	0.07	1 ¹ / ₃₂	3/8	7/16
3/4	0.15	1 ¹³ / ₃₂	1/2	1/2

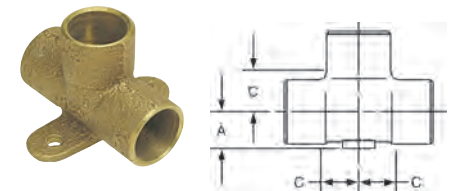

711-5 ⚠️
Drop Tee C x C x C – Cast

NOM. SIZE	APPROX. NET WT. LBS.	DIMENSIONS INCHES	
		A	C
▲ 1/2	0.16	3/8	7/16

⚠️ WARNING: This product can expose you to chemicals including lead, which is known to the State of California to cause cancer and birth defects or other reproductive harm. For more information go to www.P65Warnings.ca.gov.

▲ Also available in Lead-Free*. For additional details, see our Lead-Free* literature on www.nibco.com.

*Weighted average lead content ≤ 0.25%

TEES *continued*

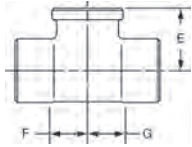

712 ▲ Tee C x C x F – Cast

NOM. SIZE	APPROX. NET WT. LBS.	DIMENSIONS INCHES		
		E	F	G
1/4	0.08	13/16	9/32	9/32
3/8	0.11	11/16	7/16	7/16
3/8 x 3/8 x 1/4	0.12	11/16	7/16	7/16
▲ 1/2	0.14	27/32	9/16	9/16
▲ 1/2 x 1/2 x 1/4	0.12	3/4	3/8	3/8
▲ 1/2 x 1/2 x 3/8	0.10	3/4	15/32	15/32
▲ 1/2 x 1/2 x 3/4	0.23	15/16	11/16	11/16
▲ 3/4	0.33	1	21/32	21/32
3/4 x 1/2 x 3/4	0.28	1	21/32	11/16
▲ 3/4 x 3/4 x 3/8	0.14	3/4	13/32	13/32
▲ 3/4 x 3/4 x 1/2	0.24	29/32	9/16	9/16
3/4 x 3/4 x 1	0.40	1 1/8	7/8	7/8
▲ 1	0.54	1 1/4	7/8	7/8
▲ 1 x 1 x 1/2	0.28	1 1/8	9/16	9/16
▲ 1 x 1 x 3/4	0.30	1	21/32	21/32
1 1/4	0.76	1 7/16	1	1
▲ 1 1/4 x 1 1/4 x 1/2	0.36	1 1/4	1/2	1/2
▲ 1 1/4 x 1 1/4 x 3/4	0.55	1 5/16	11/16	11/16
▲ 1 1/4 x 1 1/4 x 1	0.66	1 7/16	7/8	7/8
1 1/2	1.08	1 5/8	1 1/8	1 1/8
▲ 1 1/2 x 1 1/2 x 1/2	0.62	1 3/8	9/16	9/16
▲ 1 1/2 x 1 1/2 x 3/4	0.70	1 7/16	11/16	11/16
▲ 1 1/2 x 1 1/2 x 1	0.79	1 1/2	13/16	13/16
2	1.74	1 7/8	1 3/8	1 3/8
▲ 2 x 2 x 1/2	0.97	1 5/8	17/32	17/32
▲ 2 x 2 x 3/4	1.10	1 11/16	11/16	11/16
▲ 2 x 2 x 1	1.23	1 3/4	13/16	13/16

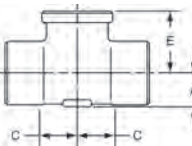

712-5 ▲ Drop Tee C x C x F – Cast

NOM. SIZE	APPROX. NET WT. LBS.	DIMENSIONS INCHES		
		A	C	E
▲ 1/2	0.18	3/8	1/2	7/8
▲ 3/4	0.38	1/2	11/16	1

Visit our website for the most current information.

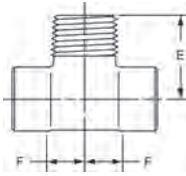

713 ▲ Tee C x C x M – Cast

NOM. SIZE	APPROX. NET WT. LBS.	DIMENSIONS INCHES	
		E	F
▲ 1/2	0.14	13/32	7/16
3/4	0.29	19/32	9/16

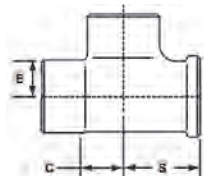

714 ▲ Tee C x F x C – Cast

NOM. SIZE	APPROX. NET WT. LBS.	DIMENSIONS INCHES		
		C	E	S
▲ 1/2	0.13	7/16	9/16	1 1/8
▲ 1/2 x 3/4 x 1/2	0.18	7/16	17/32	1 1/8
▲ 3/4	0.25	17/32	17/32	1 1/8
▲ 3/4 x 1/2 x 3/4	0.18	9/16	9/16	7/8
▲ 1	0.52	23/32	13/16	1 1/4
▲ 1 x 1/2 x 1	0.33	11/16	11/16	1 1/8
▲ 1 x 3/4 x 1	0.34	11/16	11/16	1 3/16
1 1/4	0.73	7/8	1	1 13/32
1 1/4 x 1/2 x 1 1/4	0.56	7/8	7/8	1 3/16
1 1/4 x 3/4 x 1 1/4	0.62	7/8	7/8	1 7/32
1 1/2	1.00	1	1 1/8	1 9/16
1 1/2 x 3/4 x 1 1/2	0.88	1	1	1 13/16
2	1.72	1 1/4	1 3/8	1 7/8
2 x 1/2 x 2	1.58	1 1/4	1 1/4	2
2 x 3/4 x 2	1.57	1 1/4	1 1/4	2

TRAPS

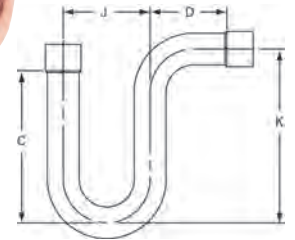
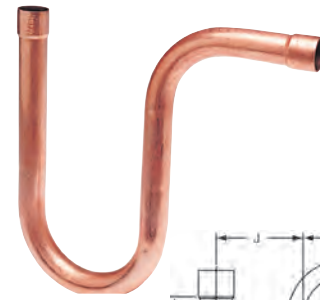

698 Suction Line P-Trap C x C – Wrot

A major application of this fitting is on the suction line of a refrigeration compressor. The line is looped, by use of the Suction Line P-Trap, to the floor prior to being run vertically upwards to prevent the drainage of oil back to the compressor during shut down periods. Additional P-Traps are used for each 20' or riser pipe. This prevents high velocity build-up as the oil or liquid begins to return to the compressor during this shut down period.

NOM. SIZE	APPROX. NET WT. LBS.	DIMENSIONS INCHES			
		C	D	J	K
1/2	0.40	5 3/8	3	3	6
5/8	0.45	5 3/8	2 7/8	3	6
3/4	0.58	5 3/8	2 3/4	3	6
1	0.92	5 1/4	2 21/32	2 31/32	6
1 1/4	1.51	5 17/32	3 1/32	3 3/4	6 1/8
1 1/2	2.74	7 29/32	3 25/32	5	9
2	4.05	8 9/32	3 29/32	6	9 13/32

WARNING: This product can expose you to chemicals including lead, which is known to the State of California to cause cancer and birth defects or other reproductive harm. For more information go to www.P65Warnings.ca.gov.

▲ Also available in Lead-Free*. For additional details, see our Lead-Free* literature on www.nibco.com.

*Weighted average lead content ≤ 0.25%

Consult price sheet for Made to Order items and for minimum order quantities.

UNIONS

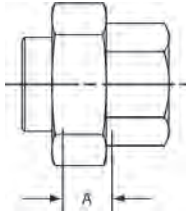
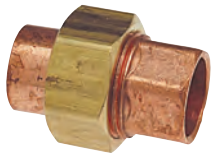

633-W ⚠
Union C x C – Wrot

NOM. SIZE	APPROX. NET WT./LBS.	DIM. A INCHES
1/4	0.13	1/2
3/8	0.12	7/16
1/2	0.12	7/16
3/4	0.28	7/16
1	0.44	1/2

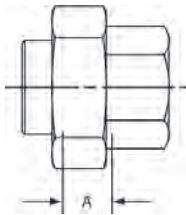

733 ⚠
Union C x C – Cast

NOM. SIZE	APPROX. NET WT./LBS.	DIM. A INCHES
1/4	0.10	11/16
3/8	0.15	7/16
1/2	0.21	13/32
5/8	0.30	21/32
3/4	0.31	3/8
1	0.53	1/2
▲ 1 1/4	0.75	9/16
▲ 1 1/2	1.06	23/32
▲ 2	1.85	1/2
▲ 2 1/2	3.33	1
▲ 3	4.75	1 5/32

⚠ WARNING: This product can expose you to chemicals including lead, which is known to the State of California to cause cancer and birth defects or other reproductive harm. For more information go to www.P65Warnings.ca.gov.

▲ Also available in Lead-Free*. For additional details, see our Lead-Free* literature on www.nibco.com.

*Weighted average lead content ≤ 0.25%

Consult price sheet for Made to Order items and for minimum order quantities.

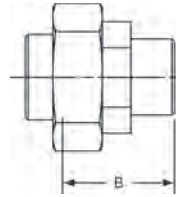

733-2 ⚠
Fitting Union Ftg x C – Cast

NOM. SIZE	APPROX. NET WT./LBS.	DIM. B INCHES
1/2	0.23	1 9/32
3/4	0.36	1 5/8
1	0.50	1 27/32

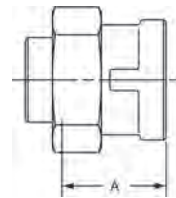

733-3 ⚠
Fitting Union C x F – Cast

NOM. SIZE	APPROX. NET WT./LBS.	DIM. A INCHES
▲ 1/4	0.14	1 5/32
▲ 3/8	0.19	1 3/32
▲ 1/2	0.27	1 1/8
▲ 3/4	0.40	1 5/16
▲ 1	0.59	1 13/32
▲ 1 1/4	0.93	1 19/32
▲ 1 1/2	1.35	1 13/16
▲ 2	1.89	1 15/16
▲ 2 1/2	3.66	–

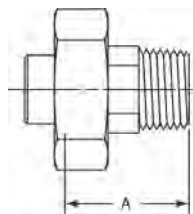

733-4 ⚠
Union C x M – Cast

NOM. SIZE	APPROX. NET WT./LBS.	DIM. A INCHES
▲ 1/4	0.13	1 1/2
▲ 3/8	0.20	1 5/8
▲ 1/2	0.29	1 11/16
1/2 x 3/4	0.35	2 1/16
▲ 3/4	0.43	1 29/32
▲ 1	0.64	2 1/8
▲ 1 1/4	0.94	2 5/32
▲ 1 1/2	1.29	2 13/32
▲ 2	2.23	2 25/32
▲ 2 1/2	4.21	3 13/32

VENTURI



621
Venturi Insert – Wrot

Converts any tee into a special purpose venturi or scoop tee

NOM. SIZE	APPROX. NET WT./LBS.
1/2	0.01
3/4	0.02
1	0.03
1 1/4	0.04

Y's

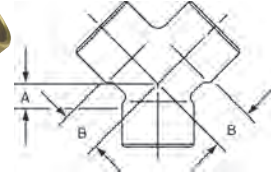

748 ⚠
90° Y C x C x C – Cast

NOM. SIZE	APPROX. NET WT./LBS.	DIM. A INCHES	DIM. B INCHES
1/2	0.11	7/32	7/16
3/4	0.25	7/16	5/8
1	0.61	1/2	13/16

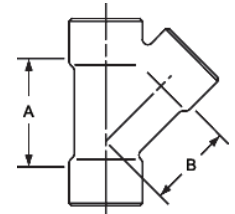

749 ⚠
45° Y C x C x C – Cast

NOM. SIZE	APPROX. NET WT./LBS.	DIM. A INCHES	DIM. B INCHES
▲ 1/2	0.15	1 3/32	7/8
▲ 3/4	0.30	1 17/32	1 7/32
▲ 1	0.55	1 13/16	1 15/32
▲ 1 1/4	0.81	2 1/4	1 7/8
1 1/2	1.14	2 5/8	2 1/8
2	2.17	3 5/16	2 3/4

Visit our website for the most current information.

Cast Copper Alloy Flared Fittings

100 Series – Heavy Flared 500 Series – Flared

Adapters	23
Couplings	23
Elbows	23
Nuts	24
Tees	24



The manufacturing plants at Stuarts Draft, VA, Nacogdoches, TX and Reynosa, Mexico manufacture products under a Quality Management System conforming to the current revision of ISO-9001 International Standards

Visit our website for the most current information.

ADAPTERS

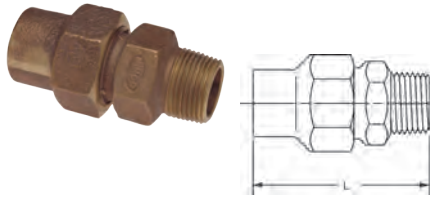

104 ⚠
Heavy Flared Adapter
FL x M – Cast

NOM. SIZE	APPROX. NET WT./LBS.	DIM. L INCHES
3/4	0.71	2 ¹ / ₂
1	1.05	3 ¹ / ₄

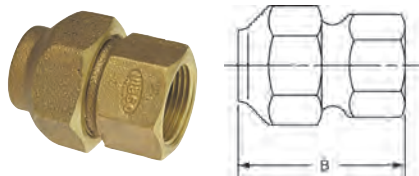

503 ⚠
Flared Adapter FL x F – Cast

NOM. SIZE	APPROX. NET WT./LBS.	DIM. B INCHES
1/2	0.36	1 ¹⁹ / ₃₂
3/4	0.49	1 ²¹ / ₃₂
1	0.93	2 ⁷ / ₃₂
1 1/2	1.98	2 ⁷ / ₁₆
2	3.27	2 ³ / ₄

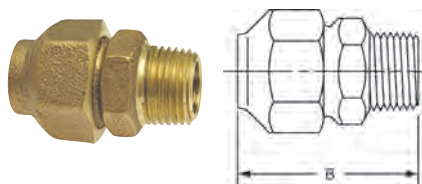

504 ⚠
Flared Adapter FL x M – Cast

NOM. SIZE	APPROX. NET WT./LBS.	DIM. B INCHES
1/2	0.28	1 ¹¹ / ₁₆
3/4	0.59	2 ⁵ / ₁₆
1	0.84	2 ¹¹ / ₁₆
1 1/2	1.88	3
2	2.93	3 ⁷ / ₁₆

Consult price sheet for Made to Order items and for minimum order quantities.

Visit our website for the most current information.

COUPLINGS

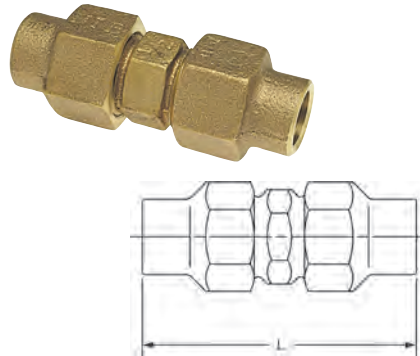

101 ⚠
Heavy Flared Coupling
FL x FL – Cast

NOM. SIZE	APPROX. NET WT./LBS.	DIM. L INCHES
3/4	0.98	3 ¹³ / ₁₆
1	1.63	5 ⁵ / ₁₆

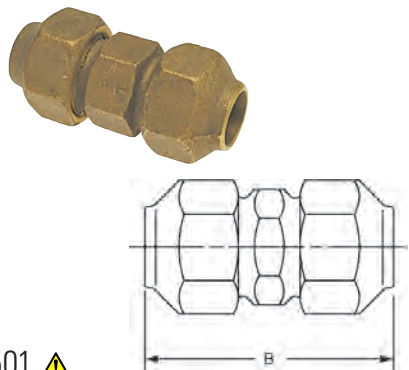

501 ⚠
Flared Coupling FL x FL – Cast

NOM. SIZE	APPROX. NET WT./LBS.	DIM. B INCHES
1/2	0.43	2 ¹ / ₁₆
3/4	0.68	2 ¹ / ₃₂
1	1.20	2 ³ / ₄
1 1/4	1.93	3 ¹ / ₄
1 1/2	2.80	3 ³ / ₈
2	4.60	3 ²⁷ / ₃₂

⚠ **WARNING:** This product can expose you to chemicals including lead, which is known to the State of California to cause cancer and birth defects or other reproductive harm. For more information go to www.P65Warnings.ca.gov.

ELBOWS

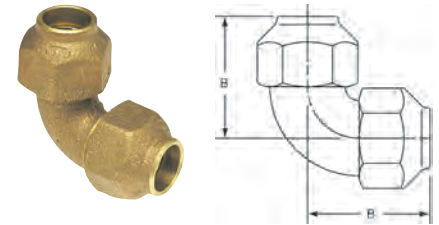

507 ⚠
Flared 90° Elbow FL x FL – Cast

NOM. SIZE	APPROX. NET WT./LBS.	DIM. B INCHES
1/2	0.54	1 ⁵ / ₈
3/4	0.88	1 ⁹ / ₁₆
1	1.59	2 ³ / ₃₂
2	5.58	3 ⁷ / ₈

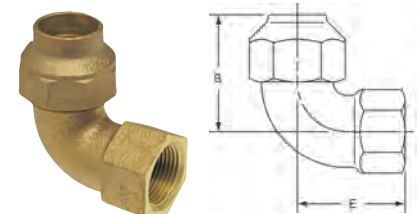

507-3 ⚠
Flared 90° Elbow FL x F – Cast

NOM. SIZE	APPROX. NET WT./LBS.	DIM. B INCHES	DIM. E INCHES
1/2	0.51	1 ⁵ / ₈	1 ¹ / ₂
3/4	0.72	1 ¹⁵ / ₁₆	1 ⁵ / ₈
1	1.45	2 ⁹ / ₁₆	2 ¹ / ₄

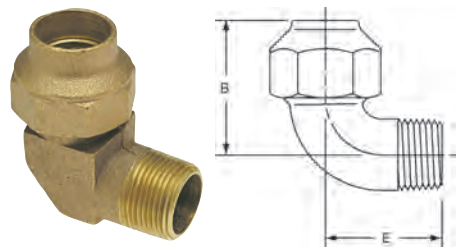

507-4 ⚠
Flared 90° Elbow FL x M – Cast

NOM. SIZE	APPROX. NET WT./LBS.	DIM. B INCHES	DIM. E INCHES
1/2	0.35	1 ³ / ₈	1 ⁷ / ₁₆
3/4	0.58	1 ⁹ / ₁₆	1 ¹⁹ / ₃₂
1	1.31	2 ³ / ₃₂	2
1 1/2	2.79	2 ⁹ / ₁₆	2 ¹ / ₂

NUTS

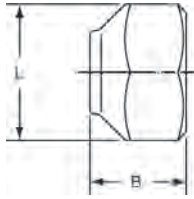

500 ⚠

Tube Nut – Cast

NOM. SIZE	APPROX. NET WT./LBS.	DIM. B INCHES	DIM. L INCHES
3/4	0.24	1 ¹ / ₁₆	1 ¹ / ₂
1	0.28	1 ³ / ₈	1 ⁷ / ₈

TEES

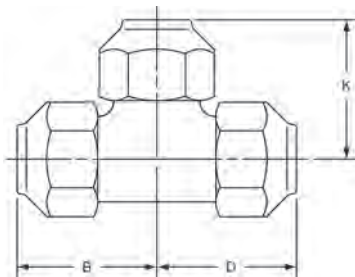

511 ⚠

Flared Tee FL x FL x FL – Cast

NOM. SIZE	APPROX. NET WT. LBS.	DIMENSIONS INCHES		
		B	D	K
1/2	0.66	1 ⁵ / ₈	1 ⁵ / ₈	1 ⁵ / ₈

⚠ WARNING: This product can expose you to chemicals including lead, which is known to the State of California to cause cancer and birth defects or other reproductive harm. For more information go to www.P65Warnings.ca.gov.

Consult price sheet for Made to Order items and for minimum order quantities.

Visit our website for the most current information.

Wrot and Cast DWV Fittings

Adapters 26-28
 Bushings 28
 Cleanouts 28
 Closet Flanges 29
 Couplings 29
 Elbows 30-31
 Plugs 31
 Tees 32
 Test Caps & Tees 32-33
 T-Y's 33
 Y's 33
 Traps 34-35
 Return Bends 35



The manufacturing plants at Stuarts Draft, VA, Nacogdoches, TX and Reynosa, Mexico manufacture products under a Quality Management System conforming to the current revision of ISO-9001 International Standards

Visit our website for the most current information.

ADAPTERS – SLIP JOINT

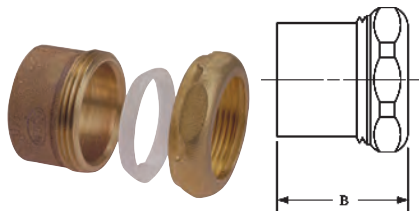

801-2-7 ⚠
DWV Fitting Trap Adapter
Ftg x SJ – Cast

NOM. SIZE	APPROX. NET WT./LBS.	DIM. B INCHES
1 1/4 x 1 1/4 O.D.	0.25	1 ³ / ₃₂

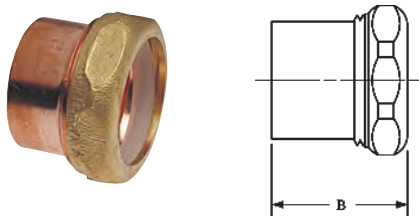

901-2-7
DWV Fitting Trap Adapter
Ftg x SJ – Wrot

NOM. SIZE	APPROX. NET WT./LBS.	DIM. B INCHES
1 1/2 x 1 1/4 O.D.	0.24	1 ¹ / ₄
1 1/2 x 1 1/2 O.D.	0.29	1 ¹ / ₈

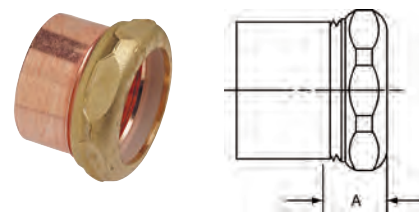

901-7
DWV Trap Adapter
C x SJ – Wrot

NOM. SIZE	APPROX. NET WT./LBS.	DIM. A INCHES
1 1/4 x 1 1/4 O.D.	0.21	2 ³ / ₃₂
1 1/2 x 1 1/4 O.D.	0.24	7/ ₈
1 1/2 x 1 1/2 O.D.	0.27	7/ ₈

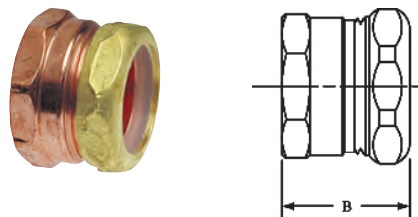

903-7
DWV Trap Adapter
F x SJ – Wrot

NOM. SIZE	APPROX. NET WT./LBS.	DIM. B INCHES
1 1/4 x 1 1/4 O.D.	0.32	1 ¹ / ₄
1 1/2 x 1 1/4 O.D.	0.43	1 ¹³ / ₃₂
1 1/2 x 1 1/2 O.D.	0.42	1 ¹ / ₄

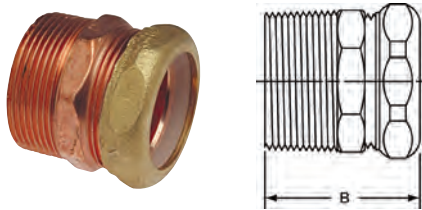

904-7
DWV Trap Adapter
M x SJ – Wrot

NOM. SIZE	APPROX. NET WT./LBS.	DIM. B INCHES
1 1/4 x 1 1/4 O.D.	0.41	1 ⁹ / ₁₆
1 1/2 x 1 1/4 O.D.	0.49	1 ²³ / ₃₂
1 1/2 x 1 1/2 O.D.	0.51	1 ¹⁹ / ₃₂

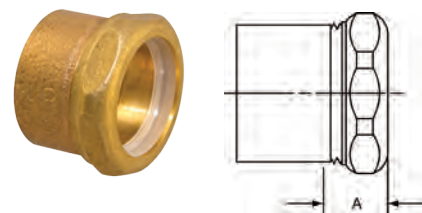

801-7 ⚠
DWV Trap Adapter
C x SJ – Cast

NOM. SIZE	APPROX. NET WT./LBS.	DIM. A INCHES
1 1/2 x 1 1/2 O.D.	0.31	2 ¹ / ₃₂

⚠ WARNING: This product can expose you to chemicals including lead, which is known to the State of California to cause cancer and birth defects or other reproductive harm. For more information go to www.P65Warnings.ca.gov.

ADAPTERS – SOIL PIPE

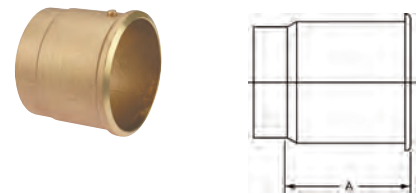

805 ⚠
DWV Soil Pipe Adapter
C x Spigot – Cast
Joins copper tube to cast iron soil pipes.

NOM. SIZE	APPROX. NET WT./LBS.	DIM. A INCHES
1 1/4 x 2	0.93	3 ⁹ / ₃₂
2 x 4	2.49	3 ⁷ / ₈
3	1.63	2 ³ / ₄
3 x 4	2.78	3 ¹³ / ₁₆
4	2.23	3

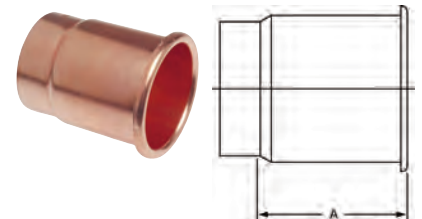

905
DWV Soil Pipe Adapter
C x Spigot – Wrot
Joins copper tube to cast iron soil pipes.

NOM. SIZE	APPROX. NET WT./LBS.	DIM. A INCHES
1 1/2 x 2	0.60	3 ⁷ / ₁₆
2	0.44	2 ¹ / ₂

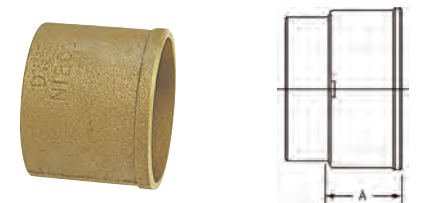

805-N ⚠
DWV No Hub Soil Pipe Adapter
C x No Hub – Cast

NOM. SIZE	APPROX. NET WT./LBS.	DIM. A INCHES
1 1/2 x 2	0.42	1 ⁷ / ₃₂
2	0.40	1 ⁷ / ₃₂
3	0.75	1 ³ / ₁₆
4	1.23	1 ⁷ / ₃₂

Consult price sheet for Made to Order items and for minimum order quantities.

Visit our website for the most current information.

ADAPTERS – SPECIAL LEAD

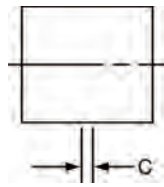

801-T ⚠
DWV Trap Adapter
C x O.D. Tube – Cast

NOM. SIZE	APPROX. NET WT./LBS.	DIM. C INCHES
1 1/4 x 1 1/4 O.D.	0.21	1/8
1 1/2 x 1 1/4 O.D.	0.20	9/32
1 1/2 x 1 1/2 O.D.	0.22	7/32

ADAPTERS – THREADED

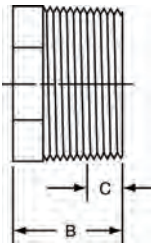

802 ⚠
DWV Adapter
C x M – Cast

NOM. SIZE	APPROX. NET WT./LBS.	DIM. B INCHES	DIM. C INCHES
1 1/4	0.23	15/16	7/16
1 1/4 x 1 1/2	0.44	1	1/2
1 1/2	0.25	1	7/16
2	0.35	1 1/16	7/16
3	0.92	1 1/2	3/4

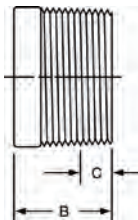

802-C ⚠
DWV Flush Adapter
C x M – Cast

NOM. SIZE	APPROX. NET WT./LBS.	DIM. B INCHES	DIM. C INCHES
1 1/2	0.20	15/16	3/8
2	0.23	1 1/16	7/16

ADAPTERS – THREADED *continued*

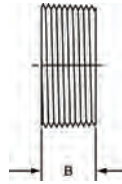

802-F ⚠
DWV Threaded Piece
C x M – Cast

Makes slip joint connection when soldered to the end of tube and slip joint nut and washer added.

NOM. SIZE	APPROX. NET WT./LBS.	DIM. B INCHES
1 1/4	0.05	3/8
1 1/2	0.06	3/8
2	0.05	3/8

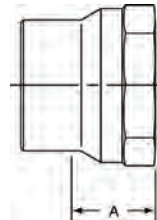

803 ⚠
DWV Adapter
C x F – Cast

NOM. SIZE	APPROX. NET WT./LBS.	DIM. A INCHES
3	1.45	1 13/32
4	2.44	1 17/32

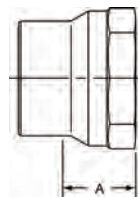

903
DWV Adapter
C x F – Wrot

NOM. SIZE	APPROX. NET WT./LBS.	DIM. A INCHES
1 1/4	0.19	29/32
1 1/2	0.25	31/32
2	0.41	1

⚠ **WARNING:** This product can expose you to chemicals including lead, which is known to the State of California to cause cancer and birth defects or other reproductive harm. For more information go to www.P65Warnings.ca.gov.

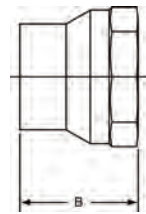

803-2 ⚠
DWV Fitting Adapter
Ftg x F – Cast

NOM. SIZE	APPROX. NET WT./LBS.	DIM. B INCHES
1 1/2	0.37	1 15/32
2	0.55	1 19/32
3	1.44	2 7/32

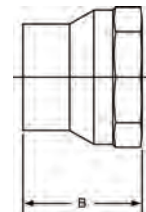
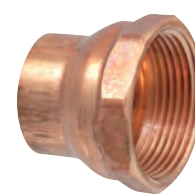

903-2
DWV Fitting Adapter
Ftg x F – Wrot

NOM. SIZE	APPROX. NET WT./LBS.	DIM. B INCHES
1 1/4	0.19	1 17/32

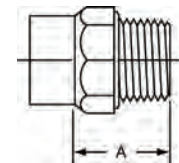

804 ⚠
DWV Adapter
C x M – Cast

NOM. SIZE	APPROX. NET WT./LBS.	DIM. A INCHES
1 1/2	0.34	29/32
1 1/2 x 1 1/4	0.31	29/32
1 1/2 x 2	0.67	1 5/16
2	0.43	7/8
2 x 1 1/2	0.52	1 5/16
3	1.35	1 15/32
4	2.59	2 1/32

Consult price sheet for Made to Order items and for minimum order quantities.

Visit our website for the most current information.

ADAPTERS – THREADED *continued*

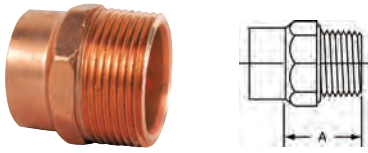

904
DWV Adapter
C x M – Wrot

NOM. SIZE	APPROX. NET WT./LBS.	DIM. A INCHES
1 1/4	0.30	1 ⁵ / ₃₂
1 1/4 x 1 1/2	0.37	1 ¹¹ / ₃₂

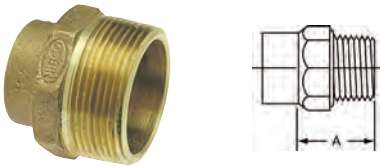

804-T
DWV Trap Adapter
O.D. Tube x M – Cast

NOM. SIZE	APPROX. NET WT./LBS.	DIM. A INCHES
1 1/4 O.D. x 1 1/2	0.44	1 ⁹ / ₃₂

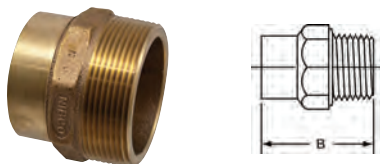

804-2
DWV Fitting Adapter
Ftg x M – Cast

NOM. SIZE	APPROX. NET WT./LBS.	DIM. B INCHES
1 1/2	0.50	1 ¹⁵ / ₁₆
2	0.71	2 ¹ / ₃₂

WARNING: This product can expose you to chemicals including lead, which is known to the State of California to cause cancer and birth defects or other reproductive harm. For more information go to www.P65Warnings.ca.gov.

Consult price sheet for Made to Order items and for minimum order quantities.

Visit our website for the most current information.

BUSHINGS

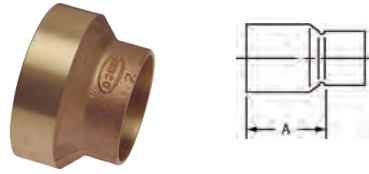

801-2
DWV External Bushing
Ftg x C – Cast

NOM. SIZE	APPROX. NET WT./LBS.	DIM. A INCHES
3 x 1 1/2	0.65	1 ⁵ / ₁₆
3 x 2	0.61	1 ¹¹ / ₃₂
4 x 2	1.09	1 ³ / ₄
4 x 3	1.12	1 ²¹ / ₃₂

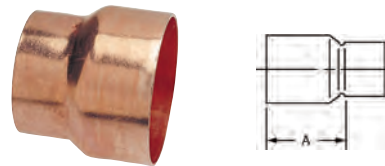

901-2
DWV External Bushing
Ftg x C – Wrot

NOM. SIZE	APPROX. NET WT./LBS.	DIM. A INCHES
1 1/2 x 1 1/4	0.13	1 ¹ / ₈
2 x 1 1/4	0.19	1 ¹ / ₂
2 x 1 1/2	0.19	1 ¹¹ / ₃₂

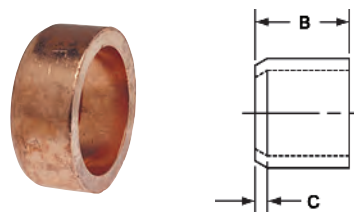

901-2-F
DWV Fitting Flush Bushing
Ftg x C – Wrot

NOM. SIZE	APPROX. NET WT./LBS.	DIM. B INCHES	DIM. C INCHES
2 x 1 1/2	0.39	1 ¹¹ / ₁₆	1/8

CLEANOUTS

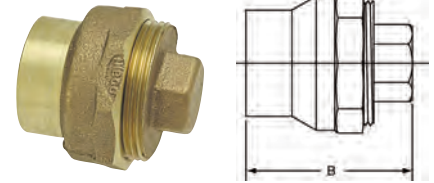

816
DWV Fitting Cleanout
Ftg x Cleanout w/Plug – Cast

NOM. SIZE	APPROX. NET WT./LBS.	DIM. B INCHES
1 1/4	0.49	2 ⁵ / ₃₂
1 1/2	0.59	2 ¹ / ₄
2	0.88	2 ³ / ₈
3	2.37	3 ⁹ / ₃₂
4	4.04	3 ⁵ / ₈

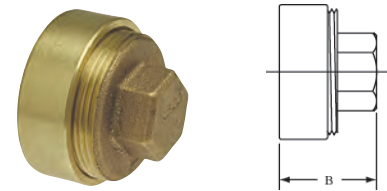

816-S
DWV Flush Fitting Cleanout
Ftg x Cleanout w/Plug – Cast

NOM. SIZE	APPROX. NET WT./LBS.	DIM. B INCHES
1 1/4 x 3/4	0.20	1 ⁵ / ₃₂
1 1/2 x 1	0.29	1 ¹ / ₁₆
2 x 1 1/2	0.41	1 ⁷ / ₃₂
3 x 2 1/2	0.96	1 ¹³ / ₁₆
4 x 3	2.13	2 ¹ / ₈

CLOSET FLANGES

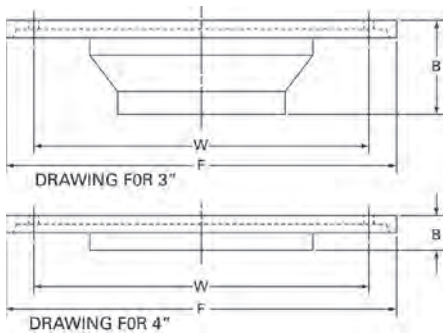
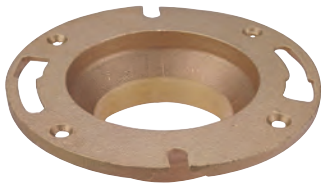

851 ⚠
DWV Closet Flange
C – Cast

NOM. SIZE	APPROX. NET WT. LBS.	DIMENSIONS INCHES		
		B	F	W
4	1.45	5/8	7	6
4 x 3	2.32	1 11/16	7	6

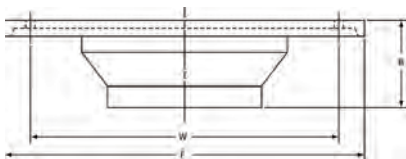

951
DWV Closet Flange
C – Wrot

NOM. SIZE	APPROX. NET WT. LBS.	DIMENSIONS INCHES		
		B	F	W
4 x 3	0.84	1 11/16	6 3/4	6

⚠ WARNING: This product can expose you to chemicals including lead, which is known to the State of California to cause cancer and birth defects or other reproductive harm. For more information go to www.P65Warnings.ca.gov.



851-C ⚠
DWV Closet Flange
C – Cast

NOM. SIZE	APPROX. NET WT. LBS.	DIMENSIONS INCHES			
		B	C	F	W
4 x 3	1.31	1 1/16	1/2	6 7/8	6

COUPLINGS

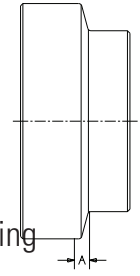

801 ⚠
DWV Coupling
C x C – Cast

NOM. SIZE	APPROX. NET WT./LBS.	DIM. A INCHES
3 x 1 1/2	0.68	15/16
3 x 2	0.70	1 1/16
4 x 2	1.34	1 1/4
4 x 3	1.13	9/32

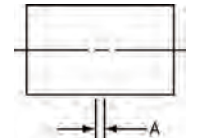

901
DWV Coupling
C x C – Wrot

NOM. SIZE	APPROX. NET WT./LBS.	DIM. A INCHES
1 1/4	0.07	3/32
1 1/2	0.09	3/32
1 1/2 x 1 1/4	0.13	9/16
2	0.14	5/32
2 x 1 1/2	0.19	23/32
3	0.45	5/32
4	0.57	3/16

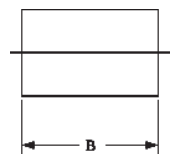

901-RP
DWV Repair Coupling (No Stop)
C x C – Wrot

NOM. SIZE	APPROX. NET WT./LBS.	DIM. B INCHES
1 1/2	0.09	1 7/32
2	0.14	1 13/32
3	0.42	1 9/16
4	0.57	2 1/8

Consult price sheet for Made to Order items and for minimum order quantities.

Visit our website for the most current information.

ELBOWS

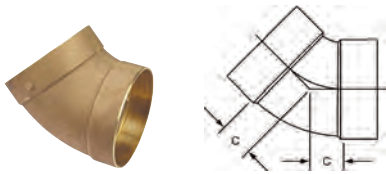

806 ⚠
DWV 45° Elbow
C x C – Cast

NOM. SIZE	APPROX. NET WT./LBS.	DIM. C INCHES
4	2.47	1 ¹⁷ / ₃₂

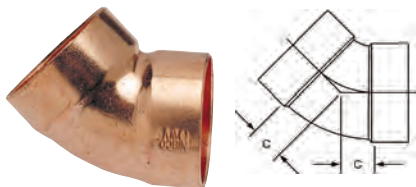

906
DWV 45° Elbow
C x C – Wrot

NOM. SIZE	APPROX. NET WT./LBS.	DIM. C INCHES
1 1/4	0.13	1/2
1 1/2	0.21	9/16
2	0.38	13/16
3	0.78	1 ¹ / ₈



806-2 ⚠
DWV 45° Fitting Elbow
Ftg x C – Cast

NOM. SIZE	APPROX. NET WT./LBS.	DIM. B INCHES	DIM. C INCHES
4	2.81	2 ¹⁹ / ₃₂	1 ¹⁷ / ₃₂

⚠ WARNING: This product can expose you to chemicals including lead, which is known to the State of California to cause cancer and birth defects or other reproductive harm. For more information go to www.P65Warnings.ca.gov.

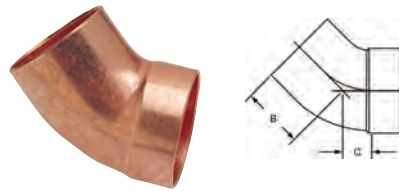

906-2
DWV 45° Fitting Elbow
Ftg x C – Wrot

NOM. SIZE	APPROX. NET WT./LBS.	DIM. B INCHES	DIM. C INCHES
1 1/4	0.13	1 ¹ / ₁₆	1/2
1 1/2	0.21	1 ¹ / ₄	9/16
2	0.39	1 ¹ / ₂	13/16
3	0.84	1 ⁷ / ₈	1 ³ / ₈

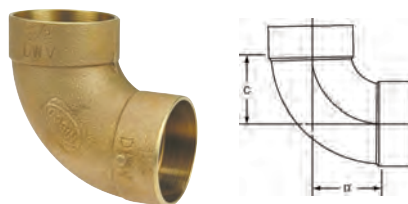

807 ⚠
DWV 90° Elbow
C x C – Cast

NOM. SIZE	APPROX. NET WT./LBS.	DIM. C INCHES	DIM. D INCHES
1 1/2 x 1 1/4	0.43	1/4	1 ⁷ / ₃₂
2 x 1 1/2	0.71	1 ¹¹ / ₁₆	1 ¹ / ₂
3	2.46	2 ⁷ / ₈	2 ⁷ / ₈
4	3.92	3 ²⁵ / ₃₂	3 ²⁵ / ₃₂

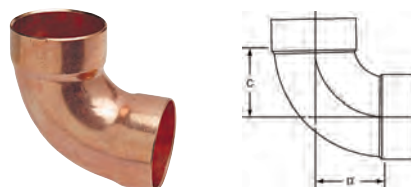

907
DWV 90° Elbow
C x C – Wrot

NOM. SIZE	APPROX. NET WT./LBS.	DIM. C INCHES	DIM. D INCHES
1 1/4	0.18	1 ³ / ₁₆	1 ³ / ₁₆
1 1/2	0.32	1 ⁷ / ₁₆	1 ⁷ / ₁₆
2	0.58	1 ¹⁵ / ₁₆	1 ¹⁵ / ₁₆
3	1.20	2 ²⁵ / ₃₂	2 ²⁵ / ₃₂

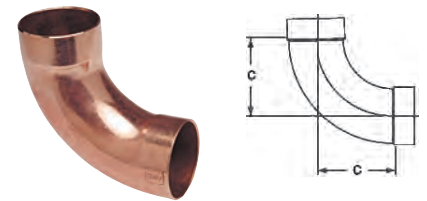

907-LT
DWV 90° Long Radius Elbow
C x C – Wrot

NOM. SIZE	APPROX. NET WT./LBS.	DIM. C INCHES
1 1/2	0.41	2 ⁵ / ₁₆
2	0.62	2 ³ / ₄

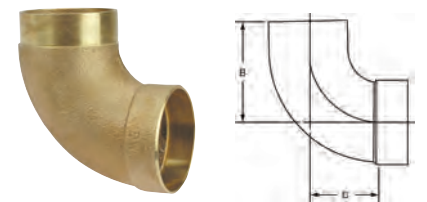

807-2 ⚠
DWV 90° Fitting Elbow
Ftg x C – Cast

NOM. SIZE	APPROX. NET WT./LBS.	DIM. B INCHES	DIM. C INCHES
4	3.84	4 ¹³ / ₁₆	3 ²⁵ / ₃₂

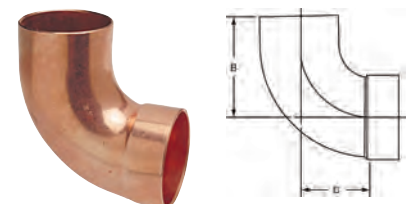

907-2
DWV 90° Fitting Elbow
Ftg x C – Wrot

NOM. SIZE	APPROX. NET WT./LBS.	DIM. B INCHES	DIM. C INCHES
1 1/4	0.19	1 ³ / ₄	1 ³ / ₁₆
1 1/2	0.33	2 ¹ / ₁₆	1 ⁷ / ₁₆
2	0.59	2 ⁵ / ₈	1 ¹⁵ / ₁₆
3	1.21	3 ¹¹ / ₁₆	2 ²⁵ / ₃₂

Consult price sheet for Made to Order items and for minimum order quantities.
Visit our website for the most current information.

ELBOWS *continued*

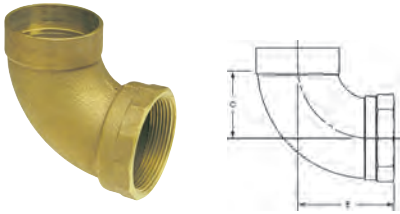

807-3 ⚠
DWV 90° Elbow
C x F – Cast

NOM. SIZE	APPROX. NET WT./LBS.	DIM. C INCHES	DIM. E INCHES
1 1/2	0.78	1 ¹³ / ₃₂	2 ¹ / ₈
2	1.31	1 ⁷ / ₈	2 ¹¹ / ₁₆

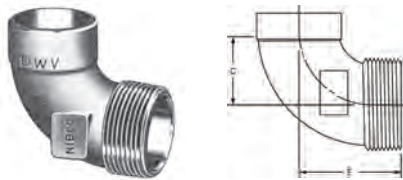

807-4 ⚠
DWV 90° Elbow
C x M – Cast

NOM. SIZE	APPROX. NET WT./LBS.	DIM. C INCHES	DIM. E INCHES
1 1/2	0.66	1 ¹³ / ₃₂	2 ³ / ₃₂

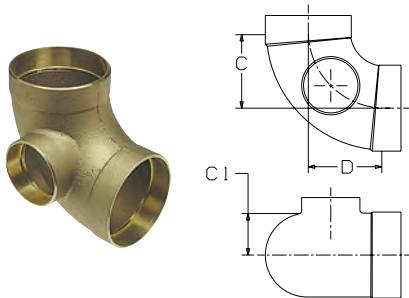

807-9 ⚠
DWV 90° Elbow w/Side Inlet
C x C x C – Cast

NOM. SIZE	APPROX. NET WT. LBS.	DIMENSIONS INCHES		
		C	C ₁	D
3 x 3 x 2	2.55	2 ⁷ / ₈	1 ⁵ / ₈	2 ⁷ / ₈

⚠ WARNING: This product can expose you to chemicals including lead, which is known to the State of California to cause cancer and birth defects or other reproductive harm. For more information go to www.P65Warnings.ca.gov.

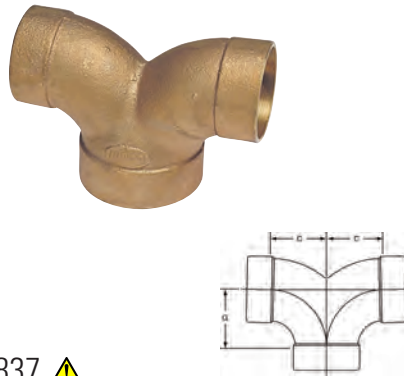

837 ⚠
DWV 90° Double Elbow
C x C x C – Cast

NOM. SIZE	APPROX. NET WT./LBS.	DIM. C INCHES	DIM. G INCHES
1 1/2	0.78	1 ¹³ / ₃₂	1 ¹³ / ₃₂
2	1.31	1 ⁷ / ₈	1 ⁷ / ₈
2 x 1 1/2 x 1 1/2	0.97	1 ⁵ / ₈	1 ¹ / ₂

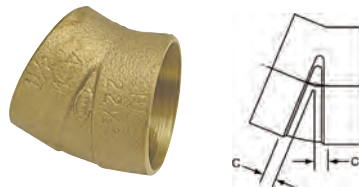

808 ⚠
DWV 22¹/₂° Elbow
C x C – Cast

NOM. SIZE	APPROX. NET WT./LBS.	DIM. C INCHES
1 1/4	0.22	3 ³ / ₁₆
1 1/2	0.27	1 ¹ / ₄
2	0.49	1 ¹¹ / ₃₂
3	0.99	1 ⁷ / ₃₂



809 ⚠
DWV 11¹/₄° Elbow
C x C – Cast

NOM. SIZE	APPROX. NET WT./LBS.	DIM. C INCHES
1 1/2	0.30	5 ⁵ / ₃₂
2	0.41	3 ³ / ₁₆

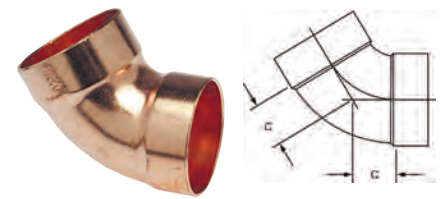

960
DWV 60° Elbow
C x C – Wrot

NOM. SIZE	APPROX. NET WT./LBS.	DIM. C INCHES
1 1/2	0.24	1 ³ / ₁₆
2	0.44	1 ¹ / ₈
3	0.95	1 ⁷ / ₈

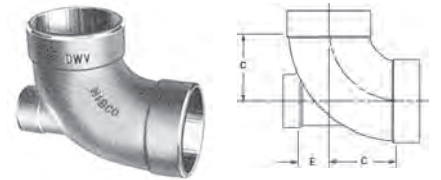

861-LH ⚠
DWV 90° Elbow
w/Low Heel Inlet
C x C x C – Cast

NOM. SIZE	APPROX. NET WT./LBS.	DIM. C INCHES	DIM. E INCHES
3 x 3 x 2	2.58	2 ¹¹ / ₁₆	1 ⁹ / ₃₂

PLUGS

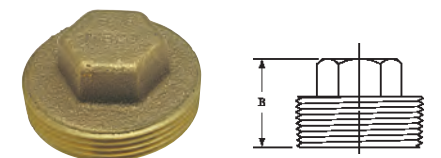

818 A.S.A. ⚠
DWV Plug
M – Cast

NOM. SIZE	APPROX. NET WT./LBS.	DIM. B INCHES
3/4	0.08	2 ³ / ₃₂
1	0.12	2 ⁹ / ₃₂
1 1/4	0.19	3 ¹ / ₃₂
1 1/2	0.22	1 ⁵ / ₁₆
2	0.33	1 ⁵ / ₁₆

Consult price sheet for Made to Order items and for minimum order quantities.

Visit our website for the most current information.

TEES



811 ⚠
DWV Tee
C x C x C – Cast

NOM. SIZE	APPROX. NET WT. LBS.	DIMENSIONS INCHES		
		C	F	G
3	2.84	2 ⁵³ / ₆₄	1 ²⁵ / ₆₄	2 ⁵³ / ₆₄
3 x 3 x 1 1/2	1.59	2 ¹ / ₁₆	1 ⁵ / ₁₆	1 ⁷ / ₁₆
3 x 3 x 2	1.82	2 ¹ / ₄	1	1 ³ / ₄
4	5.42	3 ²¹ / ₃₂	1 ²⁷ / ₃₂	3 ²¹ / ₃₂
4 x 4 x 2	2.91	2 ⁷ / ₈	1 ⁵ / ₃₂	1 ¹³ / ₁₆
4 x 4 x 3	3.71	3 ¹¹ / ₃₂	1 ¹⁹ / ₃₂	2 ⁷ / ₈



911
DWV Tee
C x C x C – Wrot

NOM. SIZE	APPROX. NET WT. LBS.	DIMENSIONS INCHES		
		C	F	G
1 1/4	0.32	1 ⁵ / ₃₂	1 ³ / ₁₆	1 ⁵ / ₃₂
1 1/2	0.49	1 ³ / ₈	7 ⁷ / ₈	1 ¹⁵ / ₁₆
1 1/2 x 1 1/2 x 1 1/4	0.39	1 ¹¹ / ₃₂	2 ⁷ / ₃₂	1
2	0.78	1 ⁷ / ₈	1 ³ / ₁₆	1 ¹³ / ₁₆
2 x 1 1/2 x 1 1/2	0.73	1 ¹⁹ / ₃₂	1 ³ / ₁₆	1 ⁷ / ₁₆
2 x 1 1/2 x 2	0.80	1 ²⁷ / ₃₂	1 ¹⁵ / ₃₂	1 ¹³ / ₁₆
2 x 2 x 1 1/4	0.51	1 ⁵ / ₈	7 ⁷ / ₈	1 ³ / ₁₆
2 x 2 x 1 1/2	0.73	1 ⁹ / ₁₆	3 ¹ / ₃₂	1 ⁷ / ₁₆

⚠ WARNING: This product can expose you to chemicals including lead, which is known to the State of California to cause cancer and birth defects or other reproductive harm. For more information go to www.P65Warnings.ca.gov.

Consult price sheet for Made to Order items and for minimum order quantities.

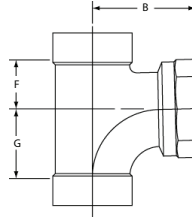

811-14 ⚠
DWV Tee
C x C x F – Cast

NOM. SIZE	APPROX. NET WT. LBS.	DIMENSIONS INCHES		
		B	F	G
1 1/2	0.88	2 ³ / ₁₆	1 ³ / ₁₆	1 ¹³ / ₃₂
2	1.57	2 ²³ / ₃₂	1 ¹ / ₁₆	1 ⁷ / ₈
2 x 2 x 1 1/2	1.17	2 ⁷ / ₁₆	7 ⁷ / ₈	1 ⁷ / ₁₆

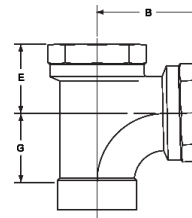

811-15 ⚠
DWV Tee
C x F x F – Cast

NOM. SIZE	APPROX. NET WT. LBS.	DIMENSIONS INCHES		
		B	E	G
1 1/4	0.82	1 ²⁵ / ₃₂	1 ¹ / ₂	1 ⁵ / ₃₂

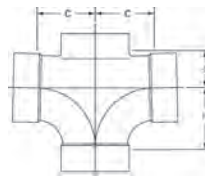

835 ⚠
DWV Double Tee
C x C x C x C – Cast

NOM. SIZE	APPROX. NET WT. LBS.	DIMENSIONS INCHES		
		C	F	G
1 1/4	0.65	1 ⁵ / ₃₂	3 ³ / ₄	1 ⁵ / ₃₂
1 1/2	0.85	1 ¹³ / ₃₂	1 ³ / ₁₆	1 ¹³ / ₃₂
1 1/2 x 1 1/2 x 1 1/4 x 1 1/4	0.72	1 ⁹ / ₃₂	3 ³ / ₄	1 ⁵ / ₃₂
2	1.39	1 ⁷ / ₈	1 ¹ / ₁₆	1 ⁷ / ₈
2 x 1 1/2 x 1 1/2 x 1 1/2	0.94	1 ²¹ / ₃₂	2 ⁵ / ₃₂	1 ⁷ / ₁₆
2 x 2 x 1 1/4 x 1 1/4	0.93	1 ¹⁷ / ₃₂	2 ⁵ / ₃₂	1 ⁵ / ₃₂
2 x 2 x 1 1/2 x 1 1/2	0.99	1 ²¹ / ₃₂	7 ⁷ / ₈	1 ⁷ / ₁₆
3 x 3 x 1 1/2 x 1 1/2	1.51	2 ¹ / ₁₆	2 ⁷ / ₃₂	1 ¹¹ / ₃₂
3 x 3 x 2 x 2	2.53	2 ³ / ₈	1 ¹ / ₈	1 ⁷ / ₈

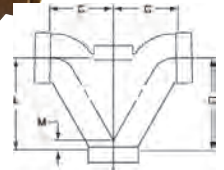

835-B ⚠
DWV Double LT Tee
C x C x C x C – Cast

NOM. SIZE	APPROX. NET WT. LBS.	DIMENSIONS INCHES			
		C	D	L	M
2 x 1 1/2 x 1 1/2 x 1 1/2	1.90	2 ³ / ₈	3 ³ / ₁₆	3 ²¹ / ₃₂	3 ³ / ₃₂

TEST CAPS

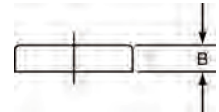

917-B ⚠
Test Caps – Copper
C – Wrot

NOM. SIZE	APPROX. NET WT./LBS.	DIM. B INCHES
1/2	0.00	3 ³ / ₁₆
3/4	0.00	3 ³ / ₁₆
1	0.01	1 ¹ / ₄
1 1/4	0.01	1 ¹ / ₄
1 1/2	0.01	1 ¹ / ₄
2	0.02	1 ¹ / ₄
3	0.03	1 ¹ / ₄

Visit our website for the most current information.

TEST TEES

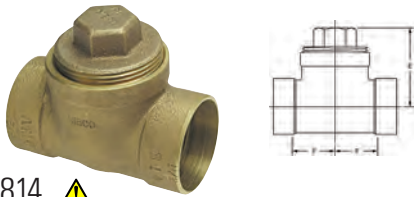

814 ⚠
DWV Test Tee
C x C x Cleanout w/Plug – Cast

NOM. SIZE	APPROX. NET WT./LBS.	DIM. E INCHES	DIM. F INCHES
1 1/2	0.88	1 ¹³ / ₃₂	1 ¹ / ₈
2	1.37	1 ²¹ / ₃₂	1 ³ / ₈
3	3.72	2 ⁹ / ₁₆	1 ¹⁵ / ₁₆

T-Y's

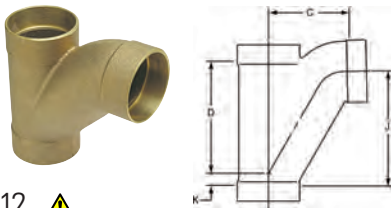

812 ⚠
DWV Long Turn T-Y
C x C x C – Cast

NOM. SIZE	APPROX. NET WT. LBS.	DIMENSIONS INCHES			
		C	D	J	K
§ 1 1/4	0.93	2 ²⁷ / ₃₂	1 ²⁷ / ₃₂	2 ³ / ₄	1 ¹³ / ₃₂
1 1/2	0.87	2 ¹ / ₂	2 ¹ / ₁₆	2 ¹¹ / ₃₂	7 ¹ / ₁₆
2	1.90	4 ¹ / ₈	2 ⁵ / ₈	3 ¹⁵ / ₁₆	3 ³ / ₈
2 x 2 x 1 1/2	1.07	3 ⁷ / ₁₆	2 ¹ / ₄	3 ¹ / ₃₂	1 ¹ / ₁₆
3	3.49	4 ¹³ / ₁₆	3 ¹⁵ / ₁₆	4 ¹ / ₂	3 ³ / ₄
3 x 3 x 2	2.78	4 ⁷ / ₈	3 ⁵ / ₁₆	4 ¹ / ₃₂	3 ³ / ₃₂

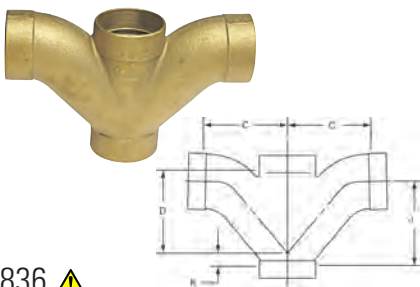

836 ⚠
DWV Double Long Turn T-Y
C x C x C x C – Cast

NOM. SIZE	APPROX. NET WT. LBS.	DIMENSIONS INCHES			
		C	D	J	K
1 1/2	1.25	3 ⁵ / ₁₆	2 ¹ / ₈	3 ⁵ / ₃₂	7 ¹ / ₃₂
2	2.83	4 ¹ / ₄	2 ³ / ₄	4 ¹ / ₁₆	1 ¹ / ₂
2 x 2 x 1 1/2 x 1 1/2	1.96	3 ⁵ / ₈	2 ³ / ₈	3 ⁷ / ₃₂	7 ¹ / ₃₂

Y's continued

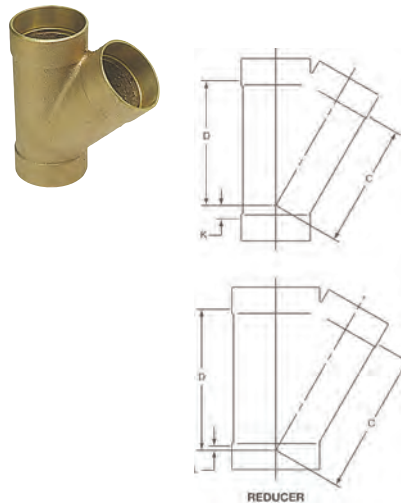

810 ⚠
DWV 45° Y
C x C x C – Cast

NOM. SIZE	APPROX. NET WT. LBS.	DIMENSIONS INCHES			
		C	D	K	L
1 1/4	0.68	2	2	3 ³ / ₈	–
1 1/2	0.94	2 ⁹ / ₃₂	2 ⁹ / ₃₂	1 ⁵ / ₃₂	–
2	1.26	2 ²³ / ₃₂	2 ²³ / ₃₂	1 ¹¹ / ₃₂	–
2 x 1 1/2 x 1 1/2	0.85	2 ⁵ / ₃₂	2 ⁵ / ₃₂	–	5 ¹ / ₁₆
2 x 1 1/2 x 2	1.16	2 ¹⁷ / ₃₂	2 ⁵ / ₈	–	1 ¹⁷ / ₃₂
2 x 2 x 1 1/4	1.01	2 ⁹ / ₁₆	2 ¹¹ / ₃₂	1 ¹ / ₁₆	–
2 x 2 x 1 1/2	1.15	2 ¹¹ / ₁₆	2 ⁹ / ₁₆	3 ¹ / ₁₆	–
3	3.19	3 ¹⁵ / ₁₆	3 ¹⁵ / ₁₆	5 ⁷ / ₈	–
3 x 3 x 1 1/2	1.69	3 ⁵ / ₁₆	2 ³ / ₄	–	1 ¹ / ₁₆
3 x 3 x 2	2.02	3 ¹⁷ / ₃₂	3 ⁵ / ₁₆	–	1 ¹ / ₈
4	5.55	5 ¹⁵ / ₃₂	5 ¹⁵ / ₃₂	1 ¹ / ₁₆	–
4 x 4 x 2	2.90	4 ³ / ₃₂	3 ¹³ / ₁₆	–	3 ³ / ₈
4 x 4 x 3	3.96	4 ¹¹ / ₁₆	4 ¹ / ₂	–	5 ¹ / ₁₆

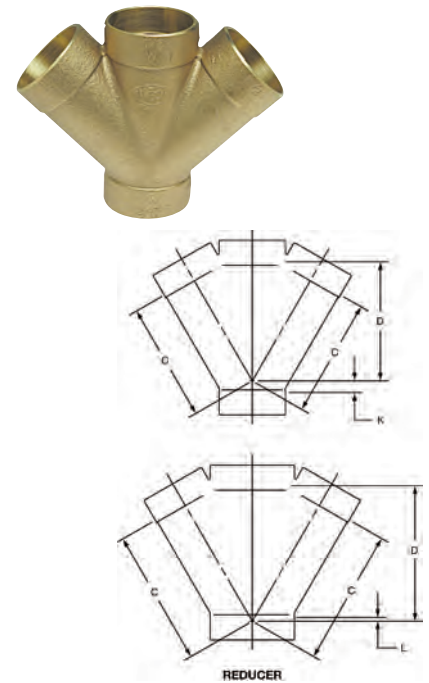

834 ⚠
DWV 45° Double Y
C x C x C x C – Cast

NOM. SIZE	APPROX. NET WT. LBS.	DIMENSIONS INCHES			
		C	D	K	L
1 1/2	1.12	2 ⁵ / ₁₆	2 ⁵ / ₁₆	1 ¹ / ₂	–
2	2.26	2 ³ / ₄	2 ³ / ₄	1 ¹³ / ₃₂	–
2 x 2 x 1 1/2 x 1 1/2	1.41	2 ¹¹ / ₁₆	2 ⁹ / ₁₆	–	3 ¹ / ₁₆
3	4.18	4 ¹³ / ₃₂	4 ¹³ / ₃₂	2 ⁵ / ₃₂	–

⚠ WARNING: This product can expose you to chemicals including lead, which is known to the State of California to cause cancer and birth defects or other reproductive harm. For more information go to www.P65Warnings.ca.gov.

Consult price sheet for Made to Order items and for minimum order quantities.

Visit our website for the most current information.

TRAPS

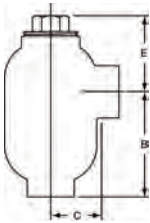

890 ⚠
3 x 5 DWV Drum Trap
w/Bottom Inlet
C x F x Cleanout w/Plug – Cast

NOM. SIZE	APPROX. NET WT. LBS.	DIMENSIONS INCHES		
		B	C	E
1 1/2	1.97	3 ⁹ / ₃₂	1 1/2	2 ³ / ₈

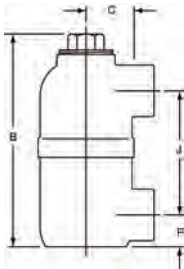

891 ⚠
3 x 6 DWV Swivel Drum Trap
C x C x Cleanout w/Plug – Cast

NOM. SIZE	APPROX. NET WT. LBS.	DIMENSIONS INCHES			
		B	C	F	J
1 1/2	2.90	6 ²¹ / ₃₂	1 1/2	1	3 ⁷ / ₈

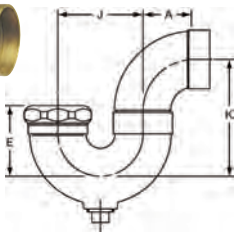

880 ⚠
DWV P-Trap w/Cleanout
C x SJ x Cleanout w/Plug – Cast

NOM. SIZE	APPROX. NET WT. LBS.	DIMENSIONS INCHES			
		A	E	J	K
1 1/2	1.80	1 ¹³ / ₃₂	2 ⁷ / ₃₂	2 1/2	3 ¹⁷ / ₃₂
2	2.76	1 ⁷ / ₈	2 ⁷ / ₁₆	3	4 ³ / ₁₆

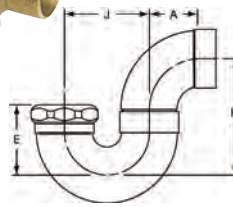

881 ⚠
DWV P-Trap
C x SJ – Cast

NOM. SIZE	APPROX. NET WT. LBS.	DIMENSIONS INCHES			
		A	E	J	K
1 1/2	1.60	1 ¹³ / ₃₂	2 ⁷ / ₃₂	2 1/2	3 ¹⁷ / ₃₂

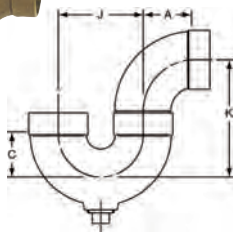

884 ⚠
DWV P-Trap w/Cleanout
C x C x Cleanout w/Plug – Cast

NOM. SIZE	APPROX. NET WT. LBS.	DIMENSIONS INCHES			
		A	C	J	K
1 1/4	1.27	1 ⁵ / ₃₂	1 ¹⁷ / ₃₂	2 1/4	3 ⁹ / ₃₂
1 1/2	1.55	1 ¹³ / ₃₂	1 ¹⁵ / ₃₂	2 1/2	3 ¹⁷ / ₃₂
2	2.40	1 ⁷ / ₈	1 ¹³ / ₃₂	3	4 ³ / ₃₂
3	5.74	2 ⁷ / ₈	1 ¹⁵ / ₁₆	4	5 ²¹ / ₃₂

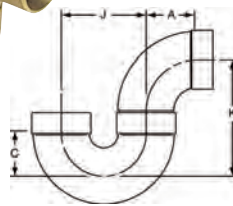

885 ⚠
DWV P-Trap
C x C – Cast

NOM. SIZE	APPROX. NET WT. LBS.	DIMENSIONS INCHES			
		A	C	J	K
1 1/4	1.16	1 ⁵ / ₃₂	1 ¹⁷ / ₃₂	2 1/4	3 ⁹ / ₃₂
1 1/2	1.41	1 ¹³ / ₃₂	1 ¹⁵ / ₃₂	2 1/2	3 ¹⁷ / ₃₂
2	2.27	1 ⁷ / ₈	1 ¹³ / ₃₂	3	4 ³ / ₃₂
3	5.17	2 ⁷ / ₈	1 ¹⁵ / ₁₆	4	5 ²¹ / ₃₂

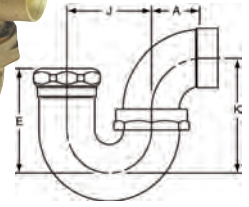

892 ⚠
DWV P-Trap w/Union
Joint
C x SJ – Cast

NOM. SIZE	APPROX. NET WT. LBS.	DIMENSIONS INCHES			
		A	E	J	K
1 1/2	1.86	1 ¹ / ₈	3 ⁵ / ₃₂	2 ⁵ / ₈	3 ⁷ / ₁₆
2	2.63	1 ¹⁵ / ₃₂	3 ¹³ / ₃₂	3 ¹ / ₈	3 ²⁹ / ₃₂

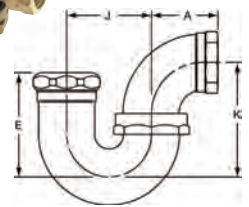

892-3 ⚠
DWV P-Trap w/Union Joint
F x SJ – Cast

NOM. SIZE	APPROX. NET WT. LBS.	DIMENSIONS INCHES			
		A	E	J	K
2	2.96	1 ¹³ / ₃₂	3 ¹³ / ₃₂	3 ¹ / ₈	3 ²⁹ / ₃₂

⚠ WARNING: This product can expose you to chemicals including lead, which is known to the State of California to cause cancer and birth defects or other reproductive harm. For more information go to www.P65Warnings.ca.gov.

Consult price sheet for Made to Order items and for minimum order quantities.

Visit our website for the most current information.

TRAPS *cont.*

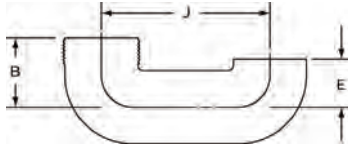

875-S ⚠
DWV Trap Upturn
M x S – Cast

NOM. SIZE	APPROX. NET WT. LBS.	DIMENSIONS INCHES		
		B	E	J
1 1/2	1.20	1 ⁴¹ / ₆₄	1 ⁹ / ₆₄	4

RETURN BENDS

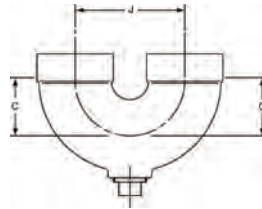

878 ⚠
DWV Return Bend w/Cleanout
C x C x Cleanout w/Plug – Cast

NOM. SIZE	APPROX. NET WT. LBS.	DIMENSIONS INCHES		
		C	J	
1 1/4	0.81	1 ¹⁷ / ₃₂	2 ¹ / ₄	–
1 1/2	0.98	1 ¹⁵ / ₃₂	2 ¹ / ₂	–
2	1.40	1 ¹⁹ / ₃₂	3	–
3	3.34	1 ¹⁵ / ₁₆	4	–

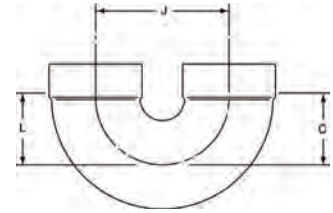

879 ⚠
DWV Return Bend
C x C – Cast

NOM. SIZE	APPROX. NET WT. LBS.	DIMENSIONS INCHES		
		C	J	L
1 1/4	0.76	1 ¹⁷ / ₃₂	2 ¹ / ₄	1 ¹⁷ / ₃₂
1 1/2	0.83	1 ¹⁵ / ₃₂	2 ¹ / ₂	–
2	1.27	1 ¹⁷ / ₃₂	3	1 ¹ / ₂
2 x 1 1/2	1.45	1 ¹⁷ / ₃₂	3	1 ¹⁹ / ₃₂
3	2.77	1 ¹⁵ / ₁₆	4	–

⚠ WARNING: This product can expose you to chemicals including lead, which is known to the State of California to cause cancer and birth defects or other reproductive harm. For more information go to www.P65Warnings.ca.gov.

Consult price sheet for Made to Order items and for minimum order quantities.

Visit our website for the most current information.

Engineering Data

Brazing Alloy	
Consumption	40
Brazing Fittings	
Dimensions	44
Installation Techniques	47-48
Copper Fittings Dimensional Data	
Solder Joing Fitting Ends	43
Brazing Fitting Ends	44
Expansion and Contraction	45
Copper Tube Fittings	
Brazing Information	40
Fitting Terms and Abbreviations	37
Plumbing System Failures	38
Rated Internal Working Pressures	41-42
Solder and Flux Requirements	40
Solder Joint Specification	39
Types of Joints	37
Frequently Asked Questions	49
Joints	
Abbreviations	37
Brazing	44-45
Soldering	43
Types	37
Rated Internal Working Pressures	41-42
Solder and Flux	
Ratings	41
Requirements	40
Solder Joint Fittings	
Dimensions	43
Installation Techniques	46

Installation Instructions

The Fine Art of Soldering	46
The Fine Art of Brazing	47-48

Numerical Index

Numerical Index	51
------------------------------	----



The manufacturing plants at Stuarts Draft, VA, Nacogdoches, TX and Reynosa, Mexico manufacture products under a Quality Management System conforming to the current revision of ISO-9001 International Standards

Copper Tube Fittings

TYPES OF JOINTS

Flared Joint — The principle of the flared joint was first developed for copper tube plumbing in 1928 by NIBCO. The flared type joint is wholly a mechanical means of joining copper tubes. The tube nut is placed over the end of the copper tube to be joined; the tube end then is flared out at an approximate 45 degree angle by a flaring tool. The flared end is then drawn up by the tube nut so the inside surface is tightly secured against the ball seat of the fitting. This joint can be readily dismantled at any time and is, in effect, a type of union connection. Its use is generally restricted to soft (annealed) copper tubes since hard drawn tubes would be subject to splitting when flared (if the ends were not previously annealed). The flared ends of NIBCO® Flared Fittings are produced to the requirements of ASME B16.26, "Cast Copper Alloy Fittings for Flared Copper Tube."

Solder Joint — NIBCO pioneered the development of the solder joint and its application to the field of copper tube piping. Today the solder joint is widely adopted, as evidenced by the majority of cities and states that have written codes to include copper tube and solder joints as desirable for general plumbing, water lines, vent, stack, waste and drain lines, as well as other uses in industry. Testing has shown that often the solder joint has greater strength than the tubes being joined, depending upon the soldering alloy selected. While the method of preparing a solder joint is an exacting art to insure a full strength joint, it can be readily mastered by skilled tradesmen. It is for this reason — to insure the public of the protection afforded by properly prepared joints — that NIBCO® products are marketed through the reputable sources of supply to the piping trades. Important procedures for preparing a solder joint are graphically illustrated in this catalog on page 46.

Brazed Joint — This type of joint has long been used wherever and whenever critical situations have been encountered in copper piping. The joint itself is completed much in the same manner as the solder joint; however, considerably more heat and several refinements of technique require separate procedures that are described further in this catalog on pages 47-48.

Threaded Ends — To adapt copper tube to equipment having National Standard Pipe Taper (NPT) threads or to add copper tube to existing iron pipe installations or other threaded connections, NIBCO provides fittings having both external and internal NPT threads. These threaded ends are produced to the requirements of ASME B1.20.1, "Pipe Threads, General Purpose (Inch)."

Flanges — To adapt copper tube to equipment having flanged connections, or to add copper tube to flanged pipe installations or other purposes, NIBCO provides flanges. The flanges are produced in two standard types widely used in this field where copper tube can serve — Class 150, comply with ASME B16.24, "Cast Copper Alloy Pipe Flanges and Flanged Fittings Class 150, 300, 400, 600, 900, 1500 and 2500"; and Class 125, which conform to MSS SP-106, "Cast Copper Alloy Flanges and Flanged Fittings Class 125, 150 and 300."

Barbed Insert Fittings for Polybutylene (PB) — NIBCO offers a complete line of copper barbed insert fittings for joining PB tube. The insert fittings are produced to the requirements of ASTM F1380. Along with the insert fittings are copper crimp rings, which, when properly installed, provide a leak-tight mechanical joint. Transition fittings are available for adapting to new or existing threaded or solder joint ends.

Fitting Terms and Abbreviations

C	Female solder cup
Ftg	Male solder end
F	Female NPT thread
M	Male NPT thread
Hose	Standard hose thread
Hub	Female end for soil pipe
Spigot	Male end for soil pipe
No Hub	Used with mechanical coupling
O.D. Tube	Actual tube outside diameter
S	Straight thread
SJ	Slip joint
FL	Flared

Visit our website for the most current information.

WHAT MAKES A PLUMBING SYSTEM FAIL?

Failure in a copper plumbing system is rare, but may occur due to a variety of reasons. The most common causes of failure are:

- Excessive fluid velocity causes erosion-corrosion or impingement (to strike or hit against) attack in the tube and/or fitting. For this reason, the copper plumbing industry has established design velocity limits for copper plumbing systems to the following:

Hot Water > 140°F (60°C)	2 to 3 feet per second (0.6 to 0.9 meters per second)
Hot Water 140°F (60°C)	4 to 5 feet per second (1.2 to 1.5 meters per second)
Cold Water	5 to 8 feet per second (1.5 to 2.4 meters per second)
- Localized high velocities and/or turbulence. The presence of a dent, tube ends which are not reamed or deburred before soldering, and sudden changes in direction can all cause localized high velocity conditions.
- Flux Corrosion is typified by pin hole leaks, generally in the bottom of a horizontal line. Fluxes are mildly corrosive liquid or petroleum-based pastes containing chlorides of zinc and ammonia. Unless the flux is flushed from the system, it will lay in the bottom of the tube and remain active. ASTM B 813, "Liquid and Paste Fluxes for Soldering Applications of Copper and Copper-Alloy Tube," limits the corrosivity of soldering fluxes and ensures that these fluxes are flushable in cold water, which facilitates easy removal of flux residue following installation.
- Galvanic Corrosion may be defined as the destruction of a material by electrochemical interaction between the environment and the material. Generally, it is slow but persistent in character and requires the presence of dissimilar metals. Galvanic corrosion requires the flow of an electric current between certain areas of dissimilar metal surfaces. To complete the electric circuit, there must be two electrodes, an anode and a cathode, and they must be connected by an electrolyte media (water) through which the current can pass. The amount of metal which dissolves at the anode is proportional to the number of electrons flowing, which in turn is dependent upon the potential and resistance of the two metals. The use of dissimilar metals in a plumbing system may or may not create a problem. For instance, copper and steel are perhaps the most common dissimilar metals found together in a plumbing system. In closed systems, such as a chilled or heating water piping, the use of dissimilar metals may not create a serious problem; this is because there is virtually no oxygen in the water and corrosion relations tend to be stifled. Where dissimilar metals must be used, some codes require that they should be separated by dielectric union or a similar type of fitting. The effectiveness depends upon; distance between the metals on the electromotive-force series (EMF) chart, ratio of cathode to anode area, degree of aeration, amount of agitation, temperature, presence of dissolved salts, and other factors.

ABBREVIATED EMF SERIES

(Electromotive-Force Series; Common Piping Materials in Sea Water)

CATHODE (+) Passive

GOLD – Fixtures, Faucets, Plating
 PLATINUM
 SILVER – Brazing alloys, Silver-bearing solders
 TITANIUM – Condenser tubes
 MONEL (67% Ni - 33% Cu) – Specialty piping & equipment
 CUPRO-NICKEL – Condensers, Marine, Nuclear
 COPPER – Pressure, DWV, Gases, Air, Refrigeration, etc.
 BRASS (85/15 - Red) – Cast fittings, Valves
 BRASS (70/30 - Yellow) – Gas-cocks, Fittings, Connectors
 LEAD – Solder, Pipe, Sheet, Coating, Lining
 TIN – Solders, Coating, Lining
 CAST IRON – Pressure, DWV
 WROUGHT IRON – Pressure
 MILD STEEL – Fire Protection
 ALUMINUM – Refrigeration, Irrigation, some Solar
 GALVANIZED STEEL – Pressure, DWV
 ZINC – Coatings, Linings, some Fittings
 MAGNESIUM – Water Heater Anodes, Cathodic protection for pipelines

ANODE (-) Active; Sacrificial Material

- Dezincification is a type of corrosion in which brass dissolves as an alloy and the copper constituent redeposits from solution onto the surface of the brass as a metal, but in the porous form. The zinc constituent may be carried away from the brass as a soluble salt, or may be deposited in place as an insoluble compound. Dezincification is normally associated with brass valves where the zinc content exceeds 15%. Generally, areas of high stress, such as valve stems and gate valve bodies, are primary targets of attack.
- On rare occasion problems of corrosion by aggressive water, possibly aggravated by poor design or workmanship, do exist. Aggressive, hard well waters that cause pitting can be identified by chemical analysis and treated to bring their composition within acceptable limits. Typically these hard waters are found to have high total dissolved solids (t.d.s.) including sulfates and chlorides, a pH in the range of 7.2 to 7.8, a high content of carbon dioxide (CO₂) gas (over 10 parts per million, ppm), and the presence of dissolved oxygen (D.O.) gas. Soft acidic waters can cause the annoying problem of green staining of fixtures or "green water". Raising the pH of such waters to a value of about 7.2 or more usually solves the problem, but a qualified water treatment specialist should be consulted.
- Aggressive soil conditions can be a cause for external corrosion of copper piping systems. Non-uniform soil characteristics, such as different soil aeration, resistivity, or moisture properties, between adjacent sections of tube can create galvanic corrosion cells. Soils contaminated with high concentrations of road salts or fertilizers containing ammonia, chlorides, and nitrogen are known to combine with water to form acids. Any metal pipe laid in ash or cinders is subject to attack by the acid generated when sulfur compounds combine with water to form sulfuric acid.

U.S. customary units in this document are the standard; the metric units are provided for reference only. The values stated in each system are not exact equivalents.

Visit our website for the most current information.

Copper Tube Fittings continued

SOLDER JOINT SPECIFICATION

- Soldering Clearance** (between the outside of the tube and the inside diameter of the solder cup) **and the Depth of the Solder Cup** (into which the tube is inserted).

Chart 1 – Soldering Clearance and Solder Cup Depth

Nominal Size of Fitting (Inches)	Maximum I.D. of Fitting		Minimum O.D. of Tube		Maximum Clearance for Soldering		Depth of Solder Cup	
	Inch	(mm)	Inch	(mm)	Inch	(mm)	Inch	(mm)
1/4	0.381	(9.66)	0.374	(9.50)	0.007	(0.18)	0.31	(7.9)
3/8	0.506	(12.85)	0.499	(12.67)	0.007	(0.18)	0.38	(9.7)
1/2	0.631	(16.03)	0.622	(15.80)	0.009	(0.23)	0.50	(12.7)
5/8	0.756	(19.20)	0.749	(19.02)	0.007	(0.18)	0.62	(15.7)
3/4	0.881	(22.38)	0.872	(22.20)	0.009	(0.23)	0.75	(19.1)
1	1.132	(28.75)	1.123	(28.54)	0.009	(0.23)	0.91	(23.1)
1 1/4	1.382	(35.10)	1.373	(34.88)	0.009	(0.23)	0.97	(24.6)
1 1/2	1.633	(41.48)	1.623	(41.22)	0.010	(0.25)	1.09	(27.7)
2 (34.0)	2.133	(54.18)	2.123	(53.92)	0.010	(0.25)	1.34	
2 1/2 (37.3)	2.633	(66.88)	2.623	(66.62)	0.010	(0.25)	1.47	
3 (42.2)	3.133	(79.58)	3.123	(79.32)	0.010	(0.25)	1.66	
3 1/2	3.633	(92.28)	3.623	(92.02)	0.010	(0.25)	1.91	(48.5)
4	4.133	(104.98)	4.123	(104.72)	0.010	(0.25)	2.16	(54.9)
5 (67.6)	5.133	(130.38)	5.123	(130.12)	0.010	(0.25)	2.66	
6	6.133	(155.78)	6.123	(155.52)	0.010	(0.25)	3.09	(78.5)

The National Bureau of Standards Report BMS58, "Strength of Soft-Soldered Joints in Copper Tubing," reporting on tests conducted with 3/4-inch tubing and fitting, says "When the clearance is greater than 0.010 inch (0.25 mm), there is difficulty in filling the joint properly."

- Depth of Solder Penetration** drastically affects the breaking load of the joint. When there is too great a soldering clearance, there is no capillary flow to assure complete solder penetration. As shown in the chart below, the holding power of the 3/4-inch joint is directly proportional to the depth of solder penetration.

For example: If you get only one-third penetration, you get approximately one-third the strength needed to assure complete satisfaction.

Chart 2 – Type K 3/4" Tubing



Solder penetration of one-third the cup depth — breaking load, approximately 2,100 lb. (955 kg)



Solder penetration of the entire cup depth — breaking load, approximately 7,000 lb. (3175 kg)

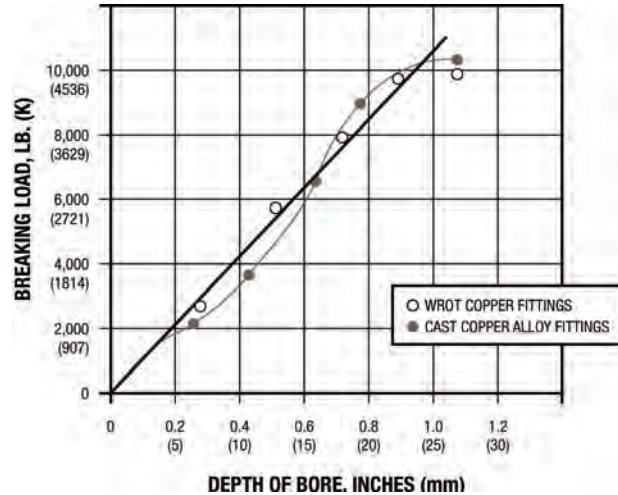

HOW TO BE SURE OF PROPER TOLERANCES

It is apparent that all of the scientific apparatus used to test tube and fittings, according to the dimensions indicated in Chart 1, would be impractical to use on the job. It is therefore essential that you install tube and fittings manufactured by companies known to be dedicated to the highest quality control standards. Should you encounter a condition where there is difficulty in filling the joint properly, NIBCO will analyze the trouble without charge. Just send six inches of the tube, along with the fitting and our technicians will provide you with an authoritative report.

Visit our website for the most current information.

U.S. customary units in this document are the standard; the metric units are provided for reference only. The values stated in each system are not exact equivalents.

BRAZING INFORMATION

Copper Water Tube Size (In Inches)	Brazing ^A Filler Required Inches (mm)		Torch Tip Drill Size No.	For Estimating Purposes					
				Acetylene Consumption C.F.H. (C.M.H.)		Oxygen Pressure (Approx.) PSI (kPa)		Acetylene Pressure (Approx.) PSI (kPa)	
1/4	0.25 ^B	(6.4)	54	15.9	(0.5)	4	(27)	4	(27)
3/8	0.38 ^B	(9.7)	54	15.9	(0.5)	4	(27)	4	(27)
1/2	0.50	(12.7)	51	24.8	(0.7)	5	(34)	5	(34)
5/8	0.62	(15.7)	51	24.8	(0.7)	5	(34)	5	(34)
3/4	1.00	(25.0)	51	24.8	(0.7)	5	(34)	5	(34)
1	1.60	(41.0)	48	31.6	(0.9)	6	(41)	6	(41)
1 1/4	2.00	(51.0)	48	31.6	(0.9)	6	(41)	6	(41)
1 1/2	2.60	(66.0)	44	38.7	(1.1)	7	(48)	7	(48)
2	4.40	(112.0)	40	60.0	(1.7)	7	(48)	7	(48)
2 1/2	5.90	(150.0)	40	60.0	(1.7)	7	(48)	7	(48)
3	7.90	(200.0)	35	70.0	(2.0)	7 1/2	(52)	7 1/2	(52)
3 1/2	10.50	(207.0)	35	70.0	(2.0)	7 1/2	(52)	7 1/2	(52)
4	13.50	(343.0)	30	88.5	(2.5)	9	(62)	9	(62)
5	20.50	(521.0)	30	88.5	(2.5)	9	(62)	9	(62)
6	28.50	(724.0)	30	88.5	(2.5)	9	(62)	9	(62)

^AApproximate consumption when brazing one cup of the fitting. Actual consumption depends on workmanship.
For filler sizes shown, one pound of filler alloy provides 1,068 inches (27.13 mm) of 1/16-inch wire or 475 inches (12,065 mm) of 3/32-inch wire.

^B1/16-inch (1.59 mm) diameter wire; all other is 3/32-inch (2.38 mm) diameter.

SOLDER AND FLUX REQUIREMENTS

Nom. Size Joint (In Inches)	Solder Required, LB (kg)	
	General Use	Drainage Use
1/4	0.097	—
3/8	0.159	—
1/2	0.261	—
5/8	0.389	—
3/4	0.548	—
1	0.856	—
1 1/4	1.115	1.2 (0.5)
1 1/2	1.480	1.4 (0.6)
2	2.380	1.5 (0.7)
2 1/2	3.225	—
3	4.335	2.8 (1.3)
3 1/2	5.786	—
4	7.446	4.2 (1.9)
5	11.392	—
6	15.815	—
8	26.955	—

Solder requirements in this table are based on estimate of weight of solder used to prepare 100 solder joints of sizes shown.

Two (2) ounces (0.06 kg) of solder flux will be required for each pound (0.45 kg) of solder.

U.S. customary units in this document are the standard; the metric units are provided for reference only. The values stated in each system are not exact equivalents.

Visit our website for the most current information.

Copper Tube Fittings continued

RATED INTERNAL WORKING PRESSURES OF JOINTS MADE WITH COPPER WATER TUBE AND SOLDER TYPE FITTINGS, PSI (BAR)

Joining Material	Working Temperature °F °C		Maximum Gauge Working Pressure for Standard Water Tube Sizes [Note (1)]								Saturated Steam LB (kg) All Sizes
			1/8" through 1" PSI BAR		1 1/4" through 2" PSI BAR		2 1/2" through 4" PSI BAR		5" through 8" PSI BAR		
Alloy Sn50 50-50 Tin-Lead solder [Notes (2), (3)]	100	38	200 (14)	175 (12)	150 (10)	135 (9)	100 (6)	90 (6)	70 (5)	15	
	150	66	150 (10)	125 (9)	100 (7)	90 (6)	70 (5)	50 (3)	40 (3)		
	200	93	100 (7)	90 (6)	75 (5)	70 (5)	50 (3)	40 (3)	30 (2)		
	250	121	85 (6)	75 (5)	50 (3)	45 (3)	40 (3)	30 (2)	20 (1)		
Alloy Sb5 95-5 Tin-Antimony solder [Note (4)]	100	38	1090 ⁽⁹⁾ (75)	850 ⁽⁸⁾ (59)	705 ⁽⁹⁾ (49)	660 ⁽⁸⁾ (46)	340 (23)	280 (19)	230 (16)	15	
	150	66	625 ⁽¹⁰⁾ (43)	485 ⁽¹⁰⁾ (34)	405 ⁽¹⁰⁾ (28)	375 ⁽¹⁰⁾ (26)	280 (19)	230 (16)	170 (12)		
	200	93	505 ⁽¹¹⁾ (35)	395 ⁽¹⁰⁾ (27)	325 ⁽¹⁰⁾ (22)	305 ⁽¹⁰⁾ (21)	230 (16)	170 (12)	120 (8)		
	250	121	270 (19)	210 (15)	175 (12)	165 (11)	120 (8)	90 (6)	70 (5)		
Alloy E	100	38	710 ⁽¹⁰⁾ (49)	555 ⁽¹⁰⁾ (38)	460 ⁽¹⁰⁾ (32)	430 ⁽¹⁰⁾ (30)	320 (22)	285 ⁽¹¹⁾ (20)	215 (15)	15	
	150	66	475 ⁽¹¹⁾ (33)	370 ⁽¹⁰⁾ (26)	305 ⁽¹⁰⁾ (21)	285 ⁽¹¹⁾ (20)	215 (15)	170 (12)	145 (9)		
	200	93	375 (26)	290 (20)	240 ⁽¹¹⁾ (17)	225 ⁽¹¹⁾ (16)	170 (12)	145 (9)	100 (7)		
	250	121	320 (22)	250 (17)	205 (14)	195 (13)	145 (9)	100 (7)	80 (5)		
Alloy HB [Note (6)]	100	38	1035 ⁽⁹⁾ (71)	805 ⁽⁸⁾ (56)	670 ⁽⁸⁾ (46)	625 ⁽⁹⁾ (43)	340 (23)	280 (19)	230 (16)	15	
	150	66	710 ⁽¹⁰⁾ (49)	555 ⁽¹⁰⁾ (38)	460 ⁽¹⁰⁾ (32)	430 ⁽¹⁰⁾ (30)	320 (22)	280 (19)	200 (14)		
	200	93	440 ⁽¹¹⁾ (30)	345 ⁽¹¹⁾ (24)	285 ⁽¹¹⁾ (20)	265 ⁽¹¹⁾ (18)	200 (14)	170 (12)	145 (9)		
	250	121	430 ⁽¹¹⁾ (30)	335 ⁽¹¹⁾ (23)	275 ⁽¹¹⁾ (19)	260 ⁽¹¹⁾ (18)	195 (13)	145 (9)	100 (7)		
Joining materials at or above 593°C [Note (7)]	Pressure-temperature ratings consistent with the materials and procedures employed.										

GENERAL NOTE:

For extremely low working temperatures in the 0°F to 200°F range, it is recommended that a joint material melting at or above 1000°F be employed [see Note (5)].

NOTES:

- (1) Standard water tube sizes per ASTM B 88
- (2) ASTM B 32 Alloy Grade Sn50
- (3) The Safe Drinking Water Act Amendment of 1986 prohibits the use of any solder having a lead content in excess of 0.2% in potable water systems.
- (4) ASTM B 32 Alloy Grade Sb5
- (5) ASTM B 32 Alloy Grade E
- (6) ASTM B 32 Alloy Grade HB
- (7) These joining materials are defined as *brazing alloys* by the American Welding Society.
- (8) The solder joint exceeds the strength of Types K, L & M tube in drawn and annealed tempers.
- (9) The solder joint exceeds the strength of Types L & M tube in drawn temper and Type K tube in annealed temper.
- (10) The solder joint exceeds the strength of Type M tube in drawn temper and Types L & K in annealed temper.
- (11) The solder joint exceeds the strength of Type L tube in annealed temper.

RATED INTERNAL WORKING PRESSURES OF JOINTS MADE WITH FLARED FITTINGS AND COPPER WATER TUBE

Nominal Size Joint (In Inches)	Temperature, °F (°C) ^A	Pressure, PSI (BAR) ^A
3/8, 1/2, 3/4, 1, 1 1/4, 1 1/2, 2	100 (38)	175 (12)

^AASME B16.26

RATED INTERNAL WORKING PRESSURES OF POLYBUTYLENE TUBE AND COPPER BARBED INSERT FITTINGS

Nominal Size Joint (In Inches)	Temperature, °F (°C)		Pressure, PSI (BAR)
	73 (23)	140 (60)	
3/8, 1/2, 3/4, 1	73 (23)	140 (60)	200 (14)
	140 (60)	180 (82)	160 (11)
	180 (82)	200 (93)	100 (7)
	200 (93)		80 (5)

Visit our website for the most current information.

U.S. customary units in this document are the standard; the metric units are provided for reference only. The values stated in each system are not exact equivalents.

RATED INTERNAL WORKING PRESSURE¹ FOR COPPER FITTINGS, PSI (BAR)

Nominal Water Tube Size (In Inches)	Water Temperature Range						
	-20° to 100°F (-29° to 38°C)	150°F (66°C)	200°F (95°C)	250°F (120°C)	300°F (149°C)	350°F (177°C)	400°F (204°C)
1/4	912 (62)	775 (53)	729 (50)	729 (50)	714 (49)	608 (42)	456 (31)
3/8	779 (54)	662 (46)	623 (43)	623 (43)	610 (42)	519 (36)	389 (27)
1/2	722 (50)	613 (42)	577 (40)	577 (40)	565 (39)	481 (33)	361 (25)
5/8	631 (43)	537 (37)	505 (35)	505 (35)	495 (34)	421 (29)	316 (21)
3/4	582 (40)	495 (34)	466 (32)	466 (32)	456 (31)	388 (27)	291 (20)
1	494 (34)	420 (29)	395 (27)	395 (27)	387 (26)	330 (23)	247 (17)
1 1/4	439 (30)	373 (26)	351 (24)	351 (24)	344 (23)	293 (20)	219 (15)
1 1/2	408 (28)	347 (24)	327 (23)	327 (23)	320 (22)	272 (19)	204 (14)
2	364 (25)	309 (21)	291 (20)	291 (20)	285 (20)	242 (17)	182 (13)
2 1/2	336 (23)	285 (20)	269 (19)	269 (19)	263 (18)	224 (15)	168 (12)
3	317 (22)	270 (19)	254 (17)	254 (17)	248 (17)	211 (15)	159 (11)
3 1/2	304 (21)	258 (18)	243 (17)	243 (17)	238 (16)	202 (14)	152 (10)
4	293 (20)	249 (17)	235 (16)	235 (16)	230 (16)	196 (13)	147 (10)
5	269 (19)	229 (16)	215 (15)	215 (15)	211 (15)	179 (12)	135 (9)
6	251 (17)	213 (15)	201 (14)	201 (14)	196 (14)	167 (12)	125 (8)
8	270 (19)	230 (16)	216 (15)	216 (15)	212 (15)	180 (12)	135 (9)

¹ The fitting pressure rating applies to the largest opening of the fitting.

RATED INTERNAL WORKING PRESSURES OF CAST COPPER ALLOY FLANGES AND FLANGED FITTINGS

Nominal Size Joint (In Inches)	Temperature °F (°C) ^A	Pressure (PSI)		
		Class 125 ^{A,B}	Class 150 ^B	Class 150 ^{A,C}
1/2, 3/4, 1, 1 1/4, 1 1/2, 2, 2 1/2, 3, 4, 5, 6, 8 (also 10" for Class 125)	0 – 150 (0 – 66)	105 (7)	210 (14)	225 (15)
	175 (79)	100 (7)	205 (14)	220 (15)
	200 (93)	95 (7)	195 (13)	210 (15)
	225 (107)	90 (6)	190 (13)	205 (14)
	250 (121)	90 (6)	180 (12)	195 (13)
	275 (135)	85 (6)	175 (12)	190 (13)
	300 (149)	85 (6)	170 (12)	180 (12)
	350 (177)	75 (5)	150 (10)	165 (11)
406 (208)	70 (5)	140 (9)	150 (10)	

^AMSS SP-106

^BASTM B584, UNS C83800 and UNS C84400

^CASTM B62, UNS C83600 and ASTM B584, UNS C83600

U.S. customary units in this document are the standard; the metric units are provided for reference only. The values stated in each system are not exact equivalents.

Visit our website for the most current information.

Copper Fittings Dimensional Data

The mechanics of making both the solder joint and the brazing joint are comparatively similar. Complete instructions on proper techniques of both of these joining methods are outlined in this catalog on pages 46-48.

A very important consideration in Copper Piping is the selection of the proper bonding medium. As a general rule, the working temperature of the installation is a more important consideration than the working pressures. If the working temperature is not over 250°F (121°C), either 50-50%* or 95-5% solder can be used successfully. However, if the temperature exceeds 250°F (121°C), a low temperature brazing alloy should be used, with a melting temperature somewhat in excess of 1000°F (538°C).

According to BMS report No. 58, joints made with tin or tin-alloy solders should not be subject continuously to temperatures above 250°F (121°C). A number of brazing alloys are available and a careful study should be made in every case to determine the proper alloy for the particular application.

*The Safe Drinking Water Act Amendment of 1986 prohibits the use in potable water systems of any solder having a lead content in excess of 0.2%.

DIMENSIONAL DATA – SOLDER JOINT FITTING ENDS

Nominal Water Tube Size (In Inches)	Solder Joint Fittings – Tolerances								Solder Joint Fittings Copper Alloy – Pressure ^{1,2}				Solder Joint Fittings Copper Alloy – Drainage ^{3,4}			
	Male End (Fitting Connector) Diameter				Female End (Solder Cup) Diameter				Fitting End Length		Solder Cup Length		Fitting End Length		Solder Cup Length	
	Min. Inch	Max. (mm)	Min. Inch	Max. (mm)	Min. Inch	Max. (mm)	Min. Inch	Max. (mm)	Min. Inch	Max. (mm)	Min. Inch	Max. (mm)	Min. Inch	Max. (mm)	Min. Inch	Max. (mm)
1/8	0.248	(6.30)	0.251	(6.38)	0.252	(6.40)	0.256	(6.50)	0.31	(7.9)	0.25	(6.4)	N/A	N/A	N/A	N/A
1/4	0.373	(9.47)	0.376	(9.55)	0.377	(9.58)	0.381	(9.68)	0.38	(9.7)	0.31	(7.9)	N/A	N/A	N/A	N/A
3/8	0.497	(12.62)	0.501	(12.73)	0.502	(12.75)	0.506	(12.85)	0.44	(11.2)	0.38	(9.7)	N/A	N/A	N/A	N/A
1/2	0.622	(15.80)	0.626	(15.90)	0.627	(15.93)	0.631	(16.03)	0.56	(14.2)	0.50	(12.7)	N/A	N/A	N/A	N/A
5/8	0.747	(18.97)	0.751	(19.08)	0.752	(19.10)	0.756	(19.20)	0.69	(17.5)	0.62	(15.7)	N/A	N/A	N/A	N/A
3/4	0.872	(22.15)	0.876	(22.25)	0.877	(22.28)	0.881	(22.38)	0.81	(20.6)	0.75	(19.1)	N/A	N/A	N/A	N/A
1	1.122	(28.50)	1.127	(28.63)	1.128	(28.65)	1.132	(28.75)	0.97	(24.6)	0.91	(23.1)	N/A	N/A	N/A	N/A
1 1/4	1.372	(34.85)	1.377	(34.98)	1.378	(35.00)	1.382	(35.10)	1.03	(26.2)	0.97	(24.6)	0.56	(14.2)	0.50	(12.7)
1 1/2	1.621	(41.17)	1.627	(41.33)	1.628	(41.35)	1.633	(41.48)	1.16	(29.5)	1.09	(27.7)	0.62	(15.7)	0.56	(14.2)
2	2.121	(53.87)	2.127	(54.03)	2.128	(54.05)	2.133	(54.18)	1.41	(35.8)	1.34	(34.0)	0.69	(17.5)	0.62	(15.7)
2 1/2	2.621	(66.57)	2.627	(66.73)	2.628	(66.75)	2.633	(66.88)	1.53	(38.9)	1.47	(37.3)	N/A	N/A	N/A	N/A
3	3.121	(79.27)	3.127	(79.43)	3.128	(79.45)	3.133	(79.58)	1.72	(43.7)	1.66	(42.2)	0.81	(20.6)	0.75	(19.1)
3 1/2	3.621	(91.97)	3.627	(92.13)	3.628	(92.15)	3.633	(92.28)	1.97	(50.0)	1.91	(48.5)	N/A	N/A	N/A	N/A
4	4.121	(104.67)	4.127	(104.83)	4.128	(104.85)	4.133	(104.98)	2.22	(56.4)	2.16	(54.9)	1.06	(26.9)	1.00	(25.4)
5	5.121	(130.07)	5.127	(130.23)	5.128	(130.25)	5.133	(130.38)	2.72	(69.1)	2.66	(67.6)	1.31	(33.3)	1.25	(31.8)
6	6.121	(155.47)	6.127	(155.63)	6.128	(155.65)	6.133	(79.58)	3.22	(81.8)	3.09	(78.5)	1.62	(41.1)	1.50	(38.1)
8	8.119	(206.22)	8.127	(206.43)	8.128	(206.45)	8.133	(206.58)	4.09	(103.9)	3.97	(100.8)	2.12	(53.8)	2.00	(50.8)
10	10.119	(257.02)	10.127	(257.23)	10.128	(257.25)	10.133	(257.38)	4.12	(104.6)	4.00	(101.6)	N/A	N/A	N/A	N/A
12	12.119	(307.82)	12.127	(308.03)	12.128	(308.05)	12.133	(308.18)	4.62	(117.3)	4.50	(114.3)	N/A	N/A	N/A	N/A

¹ As shown Standard ASME B16.18

² As shown Standard ASME B16.22

³ As shown Standard ASME B16.23

⁴ As shown Standard ASME B16.29

Visit our website for the most current information.

U.S. customary units in this document are the standard; the metric units are provided for reference only. The values stated in each system are not exact equivalents.

DIMENSIONAL DATA – BRAZING FITTING ENDS

Nominal Water Tube Size (In Inches)	Male End (Fitting Connector) Diameter				Female End (Brazing Cup) Diameter				Fitting End Length		Solder Cup Length	
	Min.		Max.		Min.		Max.		Min.		Min.	
	Inch	(mm)	Inch	(mm)	Inch	(mm)	Inch	(mm)	Inch	(mm)	Inch	(mm)
1/4	0.373	(9.47)	0.376	(9.55)	0.377	(9.58)	0.381	(9.68)	0.23	(5.8)	0.17	(4.3)
3/8	0.497	(12.62)	0.501	(12.73)	0.502	(12.75)	0.506	(12.85)	0.26	(6.6)	0.20	(5.1)
1/2	0.622	(15.80)	0.626	(15.90)	0.627	(15.93)	0.631	(16.03)	0.28	(7.1)	0.22	(5.6)
5/8	0.747	(18.97)	0.751	(19.08)	0.752	(19.10)	0.756	(19.20)	N/A	N/A	N/A	N/A
3/4	0.872	(22.15)	0.876	(22.25)	0.877	(22.28)	0.881	(22.38)	0.31	(7.9)	0.25	(6.4)
1	1.122	(28.50)	1.127	(28.63)	1.128	(28.65)	1.132	(28.75)	0.34	(8.6)	0.28	(7.1)
1 1/4	1.372	(34.85)	1.377	(34.98)	1.378	(35.00)	1.382	(35.10)	0.37	(9.4)	0.31	(7.9)
1 1/2	1.621	(41.17)	1.627	(41.33)	1.628	(41.35)	1.633	(41.48)	0.40	(10.2)	0.34	(8.6)
2	2.121	(53.87)	2.127	(54.03)	2.128	(54.05)	2.133	(54.18)	0.47	(11.9)	0.40	(10.2)
2 1/2	2.621	(66.57)	2.627	(66.73)	2.628	(66.75)	2.633	(66.88)	0.53	(13.5)	0.47	(11.9)
3	3.121	(79.27)	3.127	(79.43)	3.128	(79.45)	3.133	(79.58)	0.59	(15.0)	0.53	(13.5)
3 1/2	3.621	(91.97)	3.627	(92.13)	3.628	(92.15)	3.633	(92.28)	0.65	(16.5)	0.59	(15.0)
4	4.121	(104.67)	4.127	(104.83)	4.128	(104.85)	4.133	(104.98)	0.72	(18.3)	0.64	(16.3)
5	5.121	(130.07)	5.127	(130.23)	5.128	(130.25)	5.133	(130.38)	0.81	(20.6)	0.73	(18.5)
6	6.121	(155.47)	6.127	(155.63)	6.128	(155.65)	6.133	(155.78)	0.94	(23.9)	0.83	(21.1)
8	8.119	(206.22)	8.127	(206.43)	8.128	(206.45)	8.133	(206.58)	1.28	(32.5)	1.17	(29.7)
10	10.119	(257.02)	10.127	(257.23)	10.128	(257.25)	10.133	(257.38)	N/A	N/A	N/A	N/A
12	12.119	(307.82)	12.127	(308.03)	12.128	(308.05)	12.133	(308.18)	N/A	N/A	N/A	N/A

¹ In accordance with MS SP-73

U.S. customary units in this document are the standard; the metric units are provided for reference only. The values stated in each system are not exact equivalents.

Visit our website for the most current information.

EXPANSION AND CONTRACTION

In the majority of low-pressure heating systems employing copper tube and installed in small houses or private dwellings, provision for expansion and contraction is relatively simple. Mains, risers, and branches to radiators should be free or floating at one end of the line. Holes should be large enough to permit free movement of the tube, and care should be exercised so that pipe hangers and supports permit unrestricted movement and do not anchor the tube. Wrought copper tube hangers that are both practicable and neat in appearance are available.

Unusually long runs of copper tubing should be provided with an expansion bend or loop. By bending soft temper copper tube, a simple form of expansion loop can be made. With the addition of combination flared-tube to solder joint fittings, as illustrated in Figure 1, these types of loops can be used when space or other limitations exist. The correct proportions of such expansion loop to meet various conditions are shown in the accompanying table.

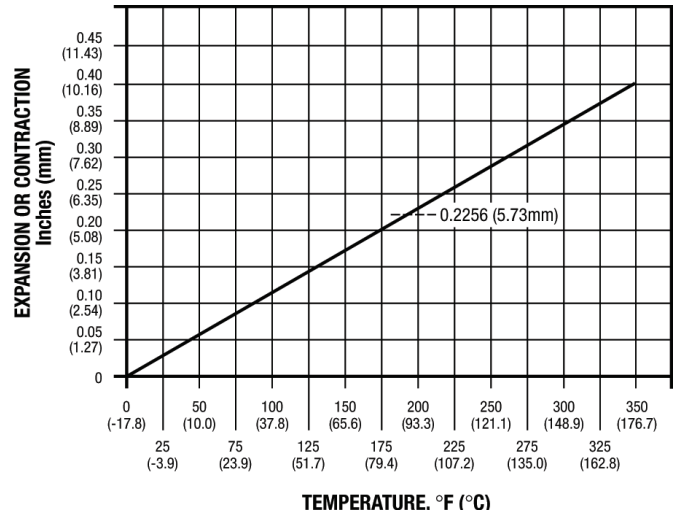
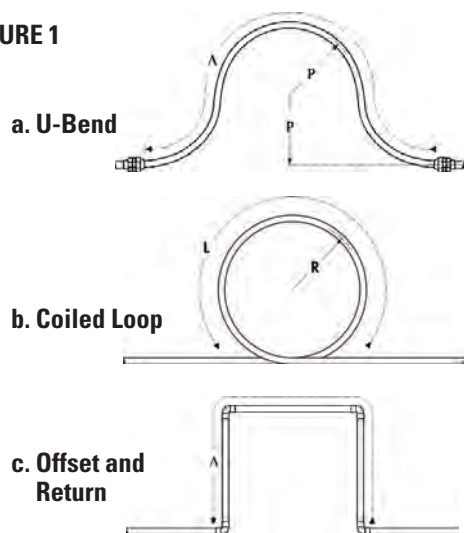

FIGURE 1



The above chart is calculated using 10ft (3.05m) of copper tubing as the reference point. You may use it as follows: 100ft (30.5m) of copper tube, with a 200°F (93.3°C) temperature change. Reference point .2256 inches for 10ft, (5.73mm for 3.05m), multiply by 10 for 100ft (30.5m), resulting in an answer of 2.256 inches (57.3mm) of expansion or contraction.

NOTE: Calculations for expansion and contraction should be based on the average coefficient of expansion of copper which is 0.0000094 per °F (0.00001692 per °C) between 77°F and 212°F (25°C and 100°C). For example, the expansion for each 10ft (3.05m) of any size of tube heated from room temperature of 70°F (21.1°C) to 170°F (76.7°C), that is, 100°F (55.6°C) rise, is:

$$\begin{matrix} \text{Rise} \\ 100^{\circ}\text{F} \\ (55.6^{\circ}\text{C}) \end{matrix} \times \begin{matrix} 10\text{ft} \\ (3.05\text{m}) \end{matrix} \times \begin{matrix} 12 \text{ inches} \\ (1000\text{mm}) \end{matrix} \times \begin{matrix} \text{Coefficient} \\ 0.000094 \\ (0.00001692) \end{matrix} = \begin{matrix} 0.1128 \text{ in.} \\ (2.87\text{mm}) \end{matrix}$$

RADI OF COILED EXPANSION LOOPS AND DEVELOPED LENGTHS OF EXPANSION OFFSETS

Nominal Tube Size	Expected Expansion															
	1/2		1		1 1/2		2		2 1/2		3		3 1/2		4	
	R	L	R	L	R	L	R	L	R	L	R	L	R	L	R	L
	Inch (mm)	Inch (mm)	Inch (mm)	Inch (mm)	Inch (mm)	Inch (mm)	Inch (mm)	Inch (mm)	Inch (mm)	Inch (mm)	Inch (mm)	Inch (mm)	Inch (mm)	Inch (mm)	Inch (mm)	Inch (mm)
1/4	6 (152.4)	38 (965.2)	9 (228.6)	54 (1371.6)	11 (279.4)	66 (1676.4)	12 (304.8)	77 (1955.8)	14 (355.6)	86 (2184.4)	15 (381.0)	94 (2387.6)	16 (406.4)	102 (2590.8)	17 (431.8)	109 (2768.6)
3/8	7 (177.8)	44 (1117.6)	10 (254.0)	63 (1600.2)	12 (304.8)	77 (1955.8)	14 (355.6)	89 (2260.6)	16 (406.4)	99 (2514.6)	17 (431.8)	109 (2768.6)	19 (482.6)	117 (2971.8)	20 (508.0)	126 (3200.4)
1/2	8 (203.2)	50 (1270.0)	11 (279.4)	70 (1778.0)	14 (355.6)	89 (2260.6)	16 (406.4)	99 (2514.6)	18 (457.2)	111 (2819.4)	19 (482.6)	122 (3098.8)	21 (533.4)	131 (3327.4)	22 (558.8)	140 (3556.0)
3/4	9 (228.6)	59 (1498.6)	13 (330.2)	83 (2108.2)	16 (406.4)	101 (2565.4)	19 (482.6)	117 (2971.8)	21 (533.4)	131 (3327.4)	23 (584.2)	143 (3632.2)	25 (635.0)	155 (3937.0)	26 (660.4)	166 (4216.4)
1	11 (279.4)	67 (1701.8)	15 (381.0)	94 (2387.6)	18 (457.2)	115 (2921.0)	21 (533.4)	133 (3378.2)	24 (609.6)	149 (3784.6)	26 (660.4)	163 (4140.2)	28 (711.2)	176 (4470.4)	30 (762.0)	188 (4775.2)
1 1/2	13 (330.2)	80 (2032.0)	18 (457.2)	113 (2870.2)	22 (558.8)	138 (3505.2)	25 (635.0)	160 (4064.0)	29 (736.6)	179 (4546.6)	31 (787.4)	196 (4978.4)	34 (863.6)	212 (5384.8)	36 (914.4)	226 (5740.4)
2	15 (381.0)	91 (2311.4)	21 (533.4)	129 (3276.6)	25 (635.0)	158 (4013.2)	29 (736.6)	183 (4648.2)	33 (838.2)	205 (5207.0)	36 (914.4)	224 (5689.6)	39 (990.6)	242 (6146.8)	41 (1041.4)	259 (6578.6)
2 1/2	16 (406.4)	102 (2590.8)	23 (584.2)	144 (3657.6)	28 (711.2)	176 (4470.4)	32 (812.8)	203 (5156.2)	36 (914.4)	227 (5765.8)	40 (1016.0)	249 (6324.6)	43 (1092.2)	269 (6832.6)	46 (1168.4)	288 (7315.2)
3	18 (457.2)	111 (2819.4)	25 (635.0)	157 (3987.8)	30 (762.0)	191 (4851.4)	35 (889.0)	222 (5638.8)	40 (1016.0)	248 (6299.2)	43 (1092.2)	272 (6908.8)	47 (1193.8)	293 (7442.2)	50 (1270.0)	314 (7975.6)
3 1/2	19 (482.6)	120 (3048.0)	27 (685.8)	169 (4292.6)	33 (838.2)	206 (5232.4)	38 (965.2)	239 (6070.6)	43 (1092.2)	267 (6781.8)	47 (1193.8)	293 (7442.2)	50 (1270.0)	316 (8026.4)	54 (1371.6)	338 (8585.2)
4	20 (508.0)	128 (3251.2)	29 (736.6)	180 (4572.0)	35 (889.0)	220 (5588.0)	41 (1041.4)	255 (6477.0)	45 (1143.0)	285 (7239.0)	50 (1270.0)	312 (7924.8)	54 (1371.6)	337 (8559.8)	57 (1447.8)	361 (9169.4)
5	23 (584.2)	142 (3606.8)	32 (812.8)	201 (5105.4)	39 (990.6)	245 (6223.0)	45 (1143.0)	284 (7213.6)	51 (1295.4)	318 (8077.2)	55 (1397.0)	348 (8839.2)	60 (1524.0)	376 (9550.4)	64 (1625.6)	402(10210.8)

U.S. customary units in this document are the standard; the metric units are provided for reference only. The values stated in each system are not exact equivalents.

Visit our website for the most current information.

The Fine Art of Soldering

When adjoining surfaces of copper and copper alloys meet under proper conditions of cleanliness and temperature, solder will make a perfect adhesion. The strength of joint is equal to or even greater than the strength of tube alone. Surface tension seals the joint. Capillary attraction draws solder into, around, and all about the joint. It's easy to learn to make a perfect solder joint when you use NIBCO® Fittings.

WITH 95-5 SOLDER AND INTERMEDIATELY CORROSIVE FLUX

1. Cut tube end square, ream, burr and size.

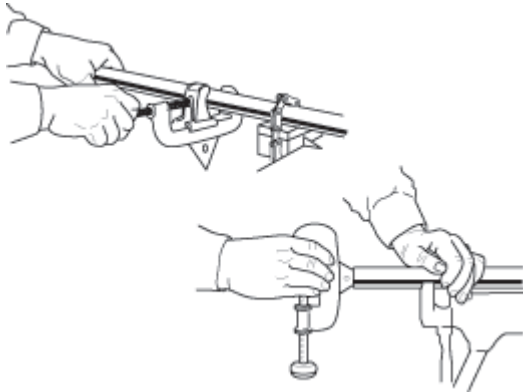

2. Use sand cloth or steel wire brush to clean tube and cup to a bright metal finish.

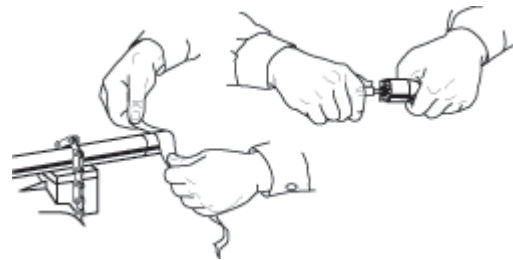

3. Apply solder flux to outside of tube and inside of cup of fitting carefully so that surfaces to be joined are completely covered. **Use flux sparingly.**



4. Apply flame to the fitting to heat tube and solder cup of fitting until solder melts when placed at joint of tube and fitting.



5. Remove flame and feed solder into the joint at one or two points until a ring of solder appears at the end of the fitting. The correct amount of solder is approximately equal to 1½ the diameter of the fitting... ¾" (20mm) solder for ½" fitting, etc.



6. Remove excess solder with a small brush or wiping cloth while the solder is plastic.



Visit our website for the most current information.

The Fine Art of Brazing

Best results will be obtained by a skilled operator employing the step-by-step brazing technique that follows:

1. The tube should be cut to desired length with a square cut, preferably in a square-end sawing vise. The cutting wheel of the type specifically designed for cutting copper tube will also do a satisfactory job. The tube should be the exact length needed, so that the tube will enter the cup of the fitting all the way to the shoulder of the cup. Remove all slivers and burrs left from cutting the tube, by reaming and filing, both inside and outside.

2. To make a proper brazing joint, the clearance between the solder cup and the tube should be approximately 0.001" to 0.010" (0.0254mm to 0.254mm). Maintaining a good fit on parts to be brazed insures:

Ease of Application — Excessively wide tolerances tend to break capillary force; and, as a result the alloy will either fail to flow throughout the joint or may flush out of the joint.

Corrosion Resistance — There is also a direct relation between the corrosion resistance of a joint and the clearance between members.

Economy — If brazing alloys are to be used economically, they, of necessity, must be applied in the joint proper and in minimum quantities, using merely enough alloy to fill the area between the members.

3. The surfaces to be joined must be clean and free from oil, grease and heavy oxides. The end of the tube need be cleaned only for a distance slightly more than it is to enter the cup. Special wire brushes designed to clean tube ends may be used, but they should be carefully used so that an excessive amount of metal will not be removed from the tube.

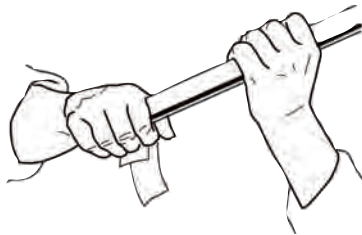

Fine sand cloth or emery cloth may also be used with the same precautions. The cleaning should not be done with steel wool, because of the likelihood of leaving small slivers of the steel or oil in the joint.

4. The cup of the fitting should be cleaned by methods similar to those used for the tube end, and care should be observed in removing residues of the cleaning medium.

Attempting to braze a contaminated or an improperly cleaned surface will result in an unsatisfactory joint. Brazing alloys will not flow over or bond to oxides; and oily or greasy surfaces tend to repel fluxes, leaving bare spots which will oxidize, resulting in voids and inclusions.



5. Flux should be applied to the tube and solder cup sparingly and in a fairly thin consistency. Avoid flux on areas not cleaned. Particularly avoid getting excess flux into the inside of the tube itself. Flux has three principal functions to perform:

A. It prevents the oxidation of the metal surfaces during the heating operation by excluding oxygen.

B. It absorbs and dissolves residual oxides that are on the surface and those oxides which may form during the heating operation.

C. It assists in the flow of the alloy by presenting a clean nascent surface for the melted alloy to flow over. In addition, it is an excellent temperature indicator, especially if an indicating flux is used.

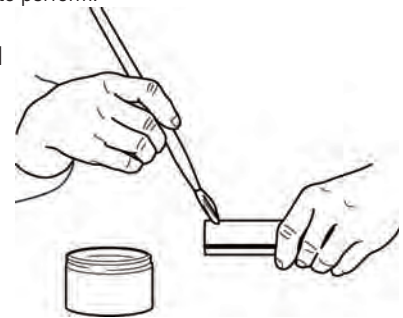

6. Immediately after fluxing, the parts to be brazed should be assembled. If fluxed parts are allowed to stand, the water in the flux will evaporate, and dried flux is liable to flake off, exposing the metal surfaces to oxidation from the heat. Assemble the joint by inserting the tube into the cup, hard against the stop. The assembly should be firmly supported so that it will remain in alignment during the brazing operation.

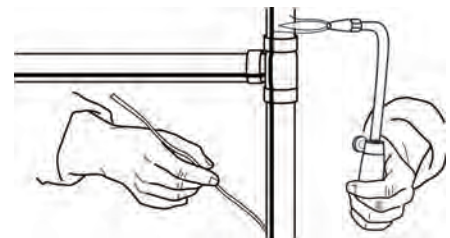

Visit our website for the most current information.

7. Brazing is started by applying heat to the parts to be joined. The preferred method is by the oxyacetylene flame. Propane and other gases are sometimes used on smaller sizes. A slightly reducing flame should be used, with a slight feather on the inner blue cone; the outer portion of the flame, pale green. Heat the tube first, beginning at about one inch from the edge of the fitting. Sweep the flames around the tube in short strokes up and down at right angles to the run of the tube. It is very important that the flame be in continuous motion and should not be allowed to remain on any one point to avoid burning through the tube. Generally, the flux may be used as a guide as to how long to heat the tube, continuing heating after the flux starts to bubble or work, and until the flux becomes quiet and transparent, like clear water. The flux will pass through four stages:

- A. At 212°F (100°C) the water boils off.
- B. At 600°F (315.6°C) the flux becomes white and slightly puffy and starts to work.
- C. At 800°F (426.7°C) it lays against the surface and has a milky appearance.
- D. At 1100°F (593.3°C) it is completely clear and active and has the appearance of water.

8. Now switch the flame to the fitting at the base of the cup. Heat uniformly, sweeping the flame from the fitting to the tube until the flux on the fitting becomes quiet. Avoid excessive heating of cast fittings.

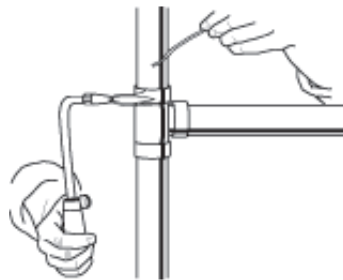

9. When the flux appears liquid and transparent on both the tube and the fitting, start sweeping the flame back and forth along the axis of the joint to maintain heat on the parts to be joined, especially toward the base of the cup of the fitting. The flame must be kept moving to avoid burning the tube or the fitting.

10. Apply the brazing wire or rod at a point where the tube enters the socket of the fitting. The temperature of the joint should be hot enough to melt the brazing alloy. Keep the flame away from the rod or wire as it is fed into the joint. Keep both the fitting and the tube heated by moving the flame back and forth from one to the other as the alloy is drawn into the joint. When the proper temperature is reached, the alloy will flow readily into the space between the tube outer wall and the fitting socket, drawn in by the natural force of capillary attraction. When the joint is filled, a continuous fillet of brazing alloy will be visible completely around the joint. Stop feeding as soon as the joint is filled.

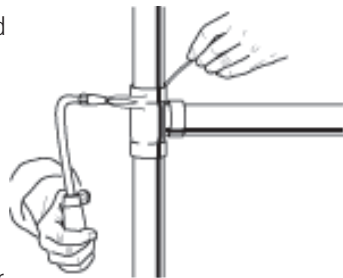

NOTE: For tubing one inch and larger, it is difficult to bring the whole joint up to heat at one time. It frequently will be found desirable to use a double-tip torch to maintain the proper temperature over the larger area. A mild pre-heating of the whole fitting is recommended. The heating then can proceed as in steps 7, 8, 9, and 10. If difficulty is encountered in getting the whole joint up to heat at one time, then when the joint is nearly up to the desired temperature the alloy is concentrated in a limited area. At the brazing temperature the alloy is fed into the joint and the torch is then moved to an adjacent area and the operation carried on progressively all around the joint.

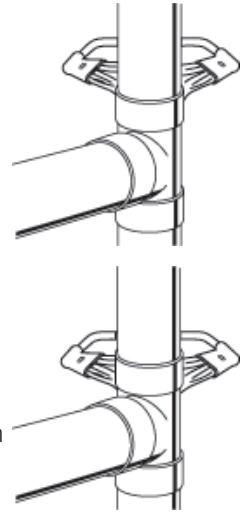

HORIZONTAL JOINTS — When making horizontal joints, it is preferable to start applying the brazing alloy at the 5 o'clock position, then move around to the 7 o'clock position and then move up the sides to the top of the joint, making sure that the operations overlap.

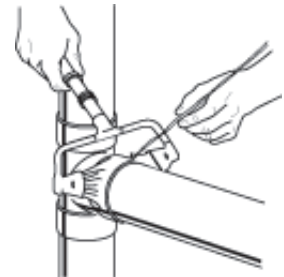

VERTICAL JOINTS — On vertical joints, it is immaterial where the start is made. If the opening of the cup is pointed down, care should be taken to avoid overheating the tube, as this may cause the alloy to run down the tube. If this condition is encountered, take the heat away and allow the alloy to set. Then reheat the solder cup of the fitting to draw up the alloy.

After the brazing alloy has set, remove residual flux from the joint area as it is corrosive and presents an unclean appearance and condition. Hot water or steam and a soft cloth should be used. Wrot fittings may be chilled; however it is advisable to allow cast fittings to cool naturally to some extent before applying a swab. All flux must be removed before inspection and pressure testing.



TROUBLE SPOTS

If the alloy fails to flow or has a tendency to ball up, it indicates oxidation on the metal surfaces, or insufficient heat on the parts to be joined. If work starts to oxidize during heating, it indicates too little flux, or a flux of too thin consistency. If the brazing alloy refuses to enter the joint and tends to flow over the outside of either member of the joint, it indicates this member is overheated, or the other is underheated, or both. In both cases, operations should be stopped and the joints disassembled, recleaned and fluxed.

Frequently Asked Questions

Q: What is the pressure rating of a given fitting?

A: Fittings are rated per Table 1 of ASME B16.22. The system rated pressure shall be the lowest of the fitting, tube or joint.

Q: When copper fails in a system, what is the problem?

A: MOST COMMON:

1. Velocity – fluid is moving too fast. Recommendation: 2-3 fps (0.0508-0.0762 m/s) hot water 140°F, 5-8 fps (0.127-0.2032 m/s) cold water.
2. Turbulence – burrs left on the cut tubing causes a tumbling effect causing localized erosion and eventual failure.
3. Aggressive Waters – tend to cause pitting or green staining of fixtures. Aggressive, hard well waters that cause pitting typically are found to have total dissolved solids including sulfates and chlorides, a pH in the range of 7.2 to 7.8, a high content of carbon dioxide gas and the presence of dissolved oxygen gas. Soft acidic waters that cause green staining typically tend to be more corrosive. Low alkalinity, low mineralization, pH levels lower than 8 should be avoided.

LESS COMMON:

1. Flux Corrosion – using too much flux when making joints can potentially leave residue and cause isolated corrosion. Flux should be used sparingly and system adequately flushed.
2. Electrolysis – stray (D.C.) current; inadequate grounding for the piping.
3. Sand or other solid particulates – erosion/corrosion problems can occur. Lower velocities must be maintained if solids are present in flow media.
4. Galvanic Corrosion – destruction of a material by electrochemical interaction between the environment and the material.

Q: Copper tubing wall thickness is designated “K,” “L” or “M.” What are the copper fittings applicable to?

A: Copper fittings’ wall thickness is determined by standards (ASME B16.22 and MSS SP-104). These standards address minimum wall thickness (per size) for the full range of copper fittings and are not intended to match tubing wall thicknesses.

Q: Can dissimilar metals (i.e., copper and iron) be joined together without use of dielectric insulators to prevent corrosion?

A: In most situations dissimilar metals (copper/iron/steel) can be joined successfully without using dielectric insulators. Factors to consider:

1. The composition of the two metals.
2. The rate of liquid flow past the two metals.
3. Chemicals in the water which could enhance or destroy protective films.
4. The relative areas of the two metals - unless the surface area of the less noble (steel) material is less than 5% of the more noble (copper) material, the need for a dielectric separator is not needed. (Failures due to galvanic corrosion are very unusual and only occur under very strict conditions.)
5. Local code requirements.

Q: What should the installer of copper unions know and do in order to assure a proper leak-free installation?

A. The following should be done:

1. Make sure the ground-joint(mating area of union’s tail and thread pieces) are free of nicks and scratches.
2. Spray the ground-joint area with a food grade silicone spray or apply bees wax to enhance seating.
3. Make sure alignment of line does not put lateral stress on the ground-joint seal.
4. Make sure that excess solder (droplets) do not reach the ground-joint area.



NIBCO INC. 50 YEAR LIMITED WARRANTY

Applicable to NIBCO INC. Copper Fittings

NIBCO INC. warrants each NIBCO® copper fitting to be free from defects in material and workmanship under normal use and service for a period of fifty (50) years from the date of original installation.

In the event any defect in material or workmanship occurs which the owner believes is covered by this warranty, the owner should immediately contact NIBCO Technical Services, either in writing or by telephone at (888) 446-4226 or (574) 295-3000. The owner will be instructed to return said product, at the owner's expense, to NIBCO INC., or to an authorized representative for inspection. In the event said inspection discloses to the satisfaction of NIBCO INC. that said fitting is defective in material or workmanship, it will be replaced at the expense of NIBCO INC. Replacements shall be shipped free of charge to the owner. This warranty is limited to the cost of repairing or replacing the product, including reasonable and customary installation.

TO THE EXTENT PERMITTED BY APPLICABLE LAW, THIS WARRANTY SPECIFICALLY EXCLUDES INCIDENTAL AND CONSEQUENTIAL DAMAGES OF EVERY TYPE AND DESCRIPTION RESULTING FROM ANY CLAIMED DEFECT IN MATERIAL OR WORKMANSHIP, INCLUDING BUT NOT LIMITED TO, PERSONAL INJURIES AND PROPERTY DAMAGES. TO THE EXTENT PERMITTED BY APPLICABLE IMPLIED WARRANTIES OF MERCHANTABILITY AND FITNESS FOR A PARTICULAR PURPOSE ARE SPECIFICALLY EXCLUDED.

This warranty gives you specific legal rights, and you may also have other rights which vary from state to state and country to country.



How to Order

State quantity, figure number and size for each fitting you wish to order. See individual fitting catalog pages for specific or special product designations.

HOW MANY TO ORDER

NIBCO® fittings are decimal packed for your convenience in handling, shipping and stock-keeping. Number in master carton varies with item.

POLICY ON RETURNS TO FACTORY

NO NIBCO fittings are to be returned without prior written agreement. Transportation must be prepaid. A 20% charge will be made to cover cost of rehandling and reinspection.

TECHNICAL ASSISTANCE

Engineers, contractors, wholesalers or manufacturers may obtain special or technical assistance from any factory representative of NIBCO. Write, fax or phone.

NIBCO INC.
World Headquarters
1516 Middlebury Street
Elkhart, IN 46516-4740
USA

Phone: 1.574.295.3000
Fax: 1.574.295.3307
Technical Service Phone: 1.888.446.4226
Fax: 1.888.336.4226

To the best of our knowledge, the information contained in this publication is accurate. However, NIBCO does not assume any liability whatsoever for the accuracy or completeness of such information. Final determinations of the suitability of any information or product for the use to be contemplated is the sole responsibility of the user. The manner of that use, and whether there is any infringement of patents, is also the sole responsibility of the user.

Visit our website for the most current information.

Numerical Index

Figure Number	Page	Figure Number	Page	Figure Number	Page	Figure Number	Page
100 Series		624.....	16	735.....	11	836.....	33
Cast Heavy Flared		633-W.....	21	736.....	10	837.....	31
101.....	23	638.....	16	739.....	16	851.....	29
104.....	23	698.....	20	741.....	15	851-C.....	29
				748.....	21	861-LH.....	31
				749.....	21	875-S.....	35
500 Series		700 Series		750.....	8	878.....	35
Cast Flared		Cast Pressure		750-3.....	8	879.....	35
500.....	24	701.....	10	750-4.....	8	880.....	34
501.....	23	701-D.....	10	764.....	14	881.....	34
503.....	23	702.....	10	771.....	15	884.....	34
504.....	23	703.....	6	775.....	15	885.....	34
507.....	23	703-2.....	6			890.....	34
507-3.....	23	703-5.....	6	800 Series Cast DWV		891.....	34
507-4.....	23	703-5B.....	6	801.....	29	892.....	34
511.....	24	704.....	7	801-2.....	28	892-3.....	34
		704-2.....	7	801-2-7.....	26		
		704-2-H.....	8	801-7.....	26	900 Series Wrot DWV	
		704-H.....	7	801-T.....	27	901.....	29
600 Series		705.....	16	802.....	27	901-2.....	28
Wrot Pressure		705-D.....	16	802-C.....	27	901-2-7.....	26
600.....	9	706-2.....	11	802-F.....	27	901-2-F.....	28
600-2.....	15	707.....	12	803.....	27	901-7.....	26
600-DS.....	10	707-2-4.....	13	803-2.....	27	901-RP.....	29
600-RS.....	9	707-3.....	13	804.....	27	903.....	27
601.....	10	707-3-5.....	13	804-2.....	28	903-2.....	27
603.....	6	707-3-5-A.....	14	804-T.....	28	903-7.....	26
603-2.....	6	707-3-6.....	14	805.....	26	904.....	28
604.....	7	707-4.....	14	805-N.....	26	904-7.....	26
604-F.....	7	707-4-6.....	14	806.....	30	905.....	26
604-2.....	7	707-5.....	14	806-2.....	30	906.....	30
606.....	11	707-5-A.....	14	807.....	30	906-2.....	30
606-2.....	11	707-6.....	14	807-2.....	30	907.....	30
607.....	11	708.....	14	807-3.....	31	907-2.....	30
607-2.....	12	710-3.....	17	807-4.....	31	907-LT.....	30
607-2-2.....	13	710-3-4.....	17	807-9.....	31	911.....	32
607-2-2-LT.....	13	711.....	19	808.....	31	917-B.....	32
607-2-I.....	12	711-5.....	19	809.....	31	951.....	29
607-2-LT.....	13	711-A.....	19	810.....	33	960.....	31
607-I.....	12	712.....	20	811.....	32		
607-LT.....	12	712-5.....	20	811-14.....	32		
611.....	17-19	713.....	20	811-15.....	32		
611-2.....	19	714.....	20	812.....	33		
611-HE.....	19	717.....	9	814.....	33		
616.....	16	717-D.....	9	816.....	28		
617.....	9	718-3.....	8	816-S.....	28		
618.....	8	724-5-A.....	16	818 A.S.A.....	31		
618-3.....	8	733.....	21	834.....	33		
619.....	8	733-2.....	21	835.....	32		
620-L.....	8	733-3.....	21	835-B.....	32		
621.....	21	733-4.....	21				
623.....	16						

Visit our website for the most current information.

NOTES

Visit our website for the most current information.

NOTES

Visit our website for the most current information.

NOTES

Visit our website for the most current information.



NIBCO®

Global Locations

MANUFACTURING PLANTS

Metal Fittings & Valves

Blytheville, Arkansas

McAllen, Texas

Nacogdoches, Texas

Stuarts Draft, Virginia

Worcester, Massachusetts

Plastic Pipe, Valves, & Fittings

Goshen, Indiana

Greensboro, Georgia

International

Lodz, Poland

Reynosa, Mexico



INTERNATIONAL OFFICES

World Headquarters

Elkhart, Indiana

European Office

Lodz, Poland



VISIT OUR WEBSITE TO LEARN MORE



Press Webstone PressACR Bench
system Chemtrol NIBCO
SURE SEAL FLO-BOSS Press
NIBCO wrot racer FAST PUSH FITTINGS Bench PressG
Bench Press Webstone PressACR
presssystem NIBCO Chem
PressG SURE SEAL FLO-BO
G NIBCO wrot racer FAST PUSH FITTINGS Bench Press
Press Webstone PressACR Bench
system Chemtrol NIBCO pr
SURE SEAL FLO-BOSS Press
NIBCO wrot racer FAST PUSH FITTINGS Bench PressG
R Bench Press Webstone Press
NIBCO presssystem Chemtro
OSS PressG SURE SEAL FLO
essACR Bench

NIBCO®

NIBCO INC.
WORLD HEADQUARTERS

1516 MIDDLEBURY STREET
ELKHART, IN 46516-4740 USA
WEB: www.nibco.com

DOMESTIC CUSTOMER SERVICE
PHONE: 800.234.0227
FAX: 800.234.0557

TECHNICAL SERVICE
PHONE: 888.446.4226
FAX: 888.336.4226

INTERNATIONAL OFFICE
PHONE: +1/574.295.3327
FAX: +1/574.295.3455