

# TA-6-way valve



## Standard control valves

6-way valve for change-over systems

# TA-6-way valve

The 6-way valve solution enables various control set-ups for heating and cooling in sequence on one terminal unit. Provides automatically adopted settings of maximum flows for heating and cooling modes together with TA-Modulator and TA-Slider 160 CO, TA-Slider 160 KNX R24 or TA-Slider 160 BACnet/Modbus CO.

## Key features

- > **Easy commissioning and balancing**  
Provides automatically adopted settings of max. flows for heating and cooling mode together with TA-Modulator and TA-Slider 160 CO, TA-Slider 160 KNX R24 or TA-Slider 160 BACnet/Modbus CO.
- > **Precise flow control**  
Provides uniquely shaped EQM characteristic for best modulating control together with TA-Modulator.
- > **Easy troubleshooting**  
Provides flow and differential pressure measuring for system diagnostics and pump optimization together with TA-Modulator.
- > **Compact installation**  
Saves space by using one terminal unit for heating and cooling.



## Technical description – Valve

### Application:

Heating and cooling systems.  
(Change-over system)

### Functions:

Control

### Dimensions:

DN 15-20

### Pressure class:

PN 16

### Max. differential pressure ( $\Delta p_V$ ):

200 kPa

### Temperature:

Max. working temperature: 120°C  
Min. working temperature: -10°C

### Media:

Water or neutral fluids, water-glycol mixtures (0-57%).

### Leakage rate:

Level A (EN 12266-1/12 - P12)

### Characteristics:

Linear, best suited for on/off control.

### Material:

Valve body: Brass CW602N  
CuZn36Pb2As (322203-13001: Brass  
CW617N CuZn40Pb2)  
Balls: Brass CW614N CuZn39Pb3  
Spindles: Brass CW614N CuZn39Pb3  
Seats: PTFE  
O-rings: EPDM (Perox)

### Surface treatment:

Valve body: Nickel-plated or non-plated  
(raw finish).  
Spindles and balls: Nickel-plated.

### Marking:

IMI TA, PN, DN.

### Connection:

External thread according to ISO 228.  
- Eurocone  
- Flat faced ends  
Internal thread according to ISO 228.

### Connection to actuator:

F03 and F04 according to EN ISO 5211.

### Angle of rotation:

90°

### Actuators:

TA-M106, TA-M106 CO, TA-MC106Y

## Technical description – Actuator

### Functions:

Proportional control  
3-point control  
Manual override

### Supply voltage:

TA-M106/24: 24 VAC +6% -10%  
TA-M106/230: 230 VAC +6% -10%  
TA-M106 CO: 24 VAC +6% -10%  
TA-MC106Y: 24 VAC ±10%

### Frequency:

50/60 Hz ±5%.

### Power consumption:

TA-M106, TA-M106 CO: 3.5 VA  
TA-MC106Y: 3.0 VA

### Input signal:

TA-M106, TA-M106 CO: 3-point  
TA-MC106Y: 0(2)-10 VDC,  $R_i$  77 k $\Omega$ .  
(0-10, 10-0, 2-10, 10-2)

### Output signal:

TA-MC106Y: 0-10 VDC (0-10, 10-0),  
max. 8 mA, min. 1.2 k $\Omega$ .

### Actuating time:

(at 50 Hz/90°)  
TA-M106, TA-M106 CO: 130 s  
TA-MC106Y: 80 s

### Adjusting torque:

8 Nm

### Temperature:

Medium temperature: max. 80°C  
Operating environment: 0°C - +50°C

### Ingress protection:

IP43

### Protection class:

EN 60730  
24 VAC: III  
230 VAC: II

### End position switch-off:

Fixed at 90°

### Cable:

1,5 m, three wire (0,5 mm<sup>2</sup>) with wire end ferrule.  
CO version: With connector to actuator  
TA-Slider 160 CO or TA-Slider 160  
BACnet/Modbus CO instead of wire end ferrules.

### Colour:

Orange RAL 2011, grey RAL 7043.

### Marking:

Label: IMI TA, CE, product name and technical specification.

### Connection to valve:

F04 according to EN ISO 5211.

### Angle of rotation:

90°

## Application examples

### Control via the actuator TA-Slider 160 CO, TA-Slider 160 KNX R24 or TA-Slider 160 BACnet/Modbus CO and the pressure independent control valve TA-Modulator

(See connection diagrams TA-Slider 160 CO + TA-M106 CO, TA-Slider 160 KNX R24 + TA-M106 and TA-Slider 160 BACnet/Modbus CO + TA-M106 CO)

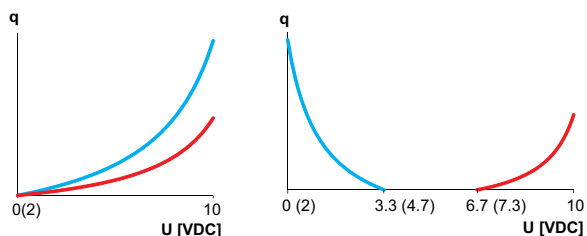
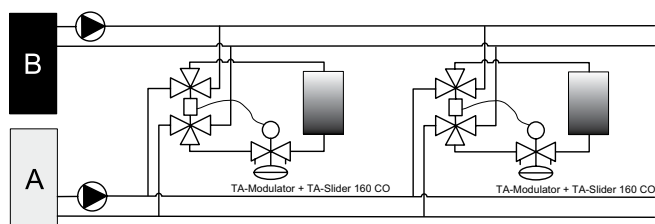

- EQM valve characteristic for best modulating control.
- High valve authority thanks to pressure independent control valve.
- Automatically adopted flow settings for heating and cooling mode.
- The 6-way valve for change-over between heating and cooling.

For more details on TA-Slider actuators, see separate technical leaflets.

### Control via the actuator TA-MC106Y and the TA-6-way valve

(See connection diagram TA-MC106Y)

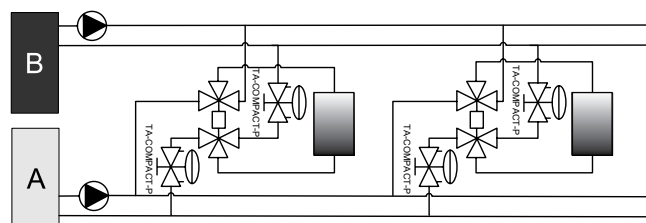

- Valve characteristic best suited for on/off-control.
- Pressure independent flow settings for heating and cooling mode with the valve TA-COMPACT-P.

### Control via the actuator TA-MC106Y and the TA-6-way valve

(See connection diagram TA-MC106Y)

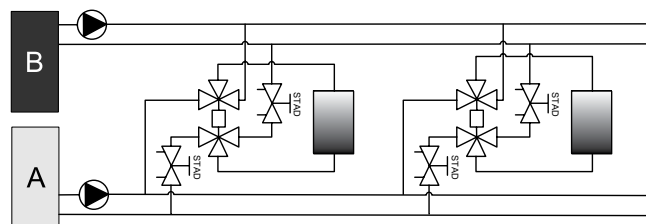

- Valve characteristic best suited for on/off-control.
- Flow balancing of heating and cooling mode with the valve STAD.

**Note:** Differential pressure control with STAP/STAD is recommended in branches for pressure independent modules.

## Installation

### Flow distribution

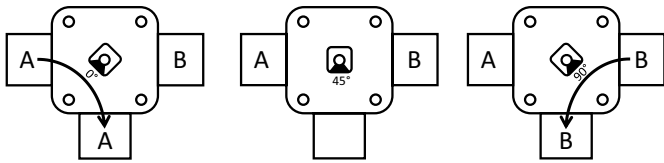
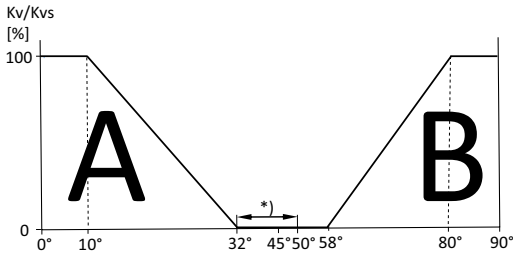

\*) Pressure balance function: Pressure connection between port 1 and 2, at 32° to 50°, for proper pressurisation of the terminal at zero flow. **NOTE!** Any control valve should be connected to port 3.

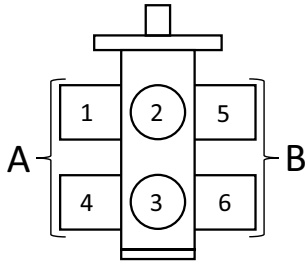

### Pressurisation

**NOTE!** When designing the pressurisation system: please consider that change-over systems have hydraulic interaction between the cooling and the heating system via the terminals, which cause a fluid mass transfer from the cooling to the heating system. For further information please contact IMI Hydronic Engineering.

### Example valve + bracket

See "Accessories"

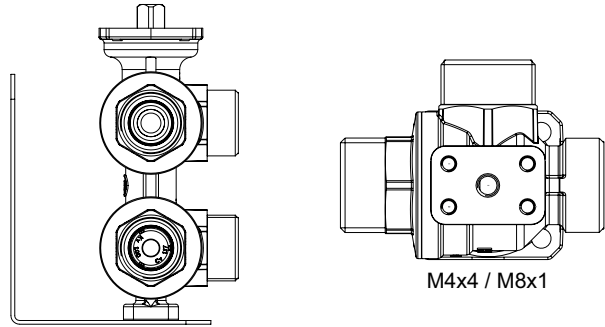

### TA-M106, TA-M106 CO, TA-MC106Y

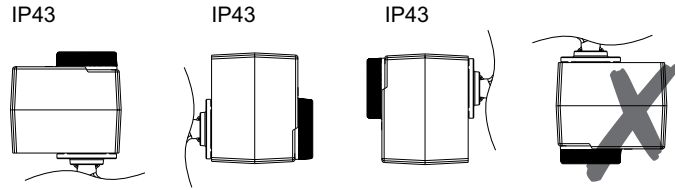

## Connection diagram – Terminal/Description

Terminal	Description
S	Shielding, line should be connected at one end to a specific shielding terminal connected itself to EARTH.
L24	Power supply 24 VAC
M	Neutral for power supply 24 VAC and signals
A (Data+)	Data+ (RS 485)
B (Data-)	Data- (RS 485)
$Y_v$	Input signal for proportional control 0(2)-10 VDC, 47 k $\Omega$
$X_v$	Output signal 0(2)-10 VDC, max. 8 mA or min. load resistance 1.25 k $\Omega$
B	Connection for potential free contact (e.g. open window detection), max. 100 $\Omega$ , max. 10 m cable or shielded
T1	Connection for Pt1000 temperature sensor, to be connected between T1 and M, max. 10 m total cable length between actuator and sensor head.
T2	Second connection for Pt1000 temperature sensor, to be connected between T2 and M, max. 10 m total cable length between actuator and sensor head.
COM	Common relay contact; CO version: to connect TA-M106 CO actuator. KNX R24 version: Max. 30 VAC/VDC, max. 2A on resistive load (to connect TA-M106 24 VAC 3-point, see "Connection diagram").
NC	Normally closed contact for relay
NO	Normally open contact for relay

 24 VAC/VDC operating only with safety transformer according to EN 61558-2-6.

## Connection diagram

### TA-M106

3-point

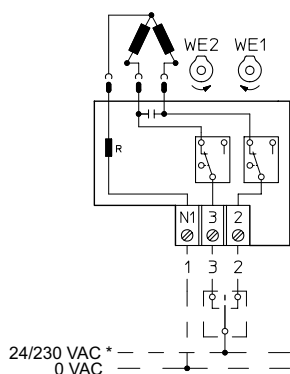

\*) Depending on TA-M106 version.

### TA-MC106Y

Proportional (0(2)-10 VDC)

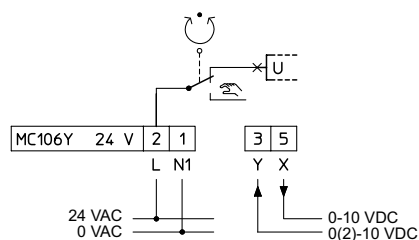

### TA-Slider 160 CO + TA-M106 CO

(See Application example 1)

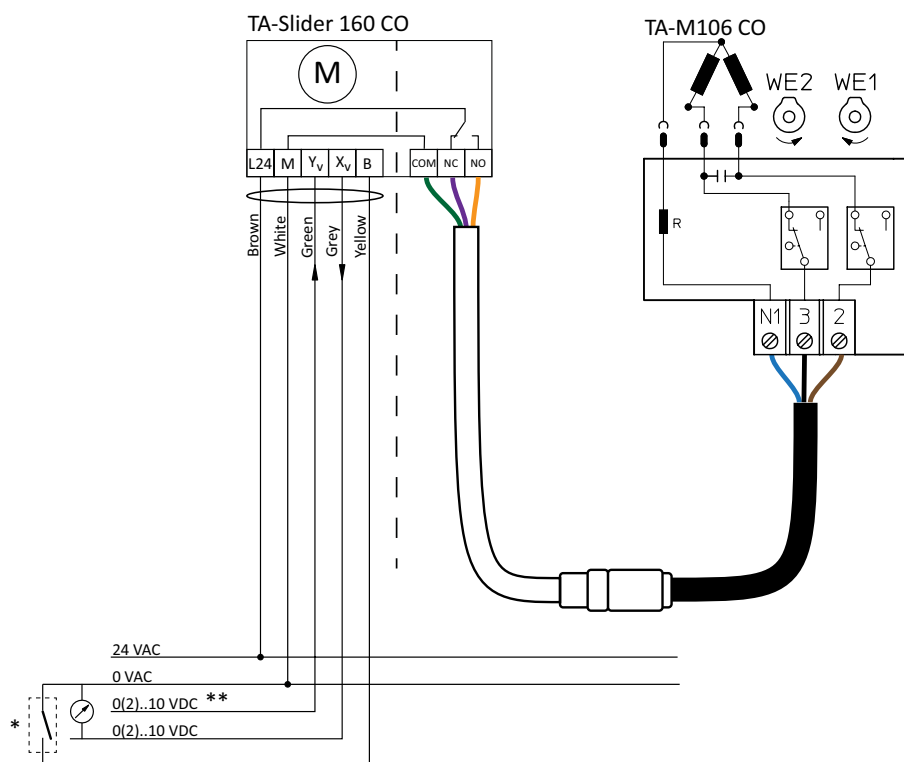

\*) Binary input can be used to toggle between heating and cooling mode as an alternative to the dual-range signal.

\*\*) Dual range signal 0-3.3/6.7-10 VDC, 2-4.7/7.3-10 VDC, 0-4.5/5.5-10 VDC or 2-5.5/6.5-10 VDC.

### Modulating control

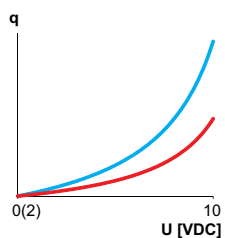

### Dual range modulating control

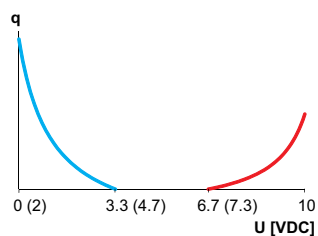

**TA-Slider 160 KNX R24 + TA-M106**

(See Application example 1)

Control by KNX bus

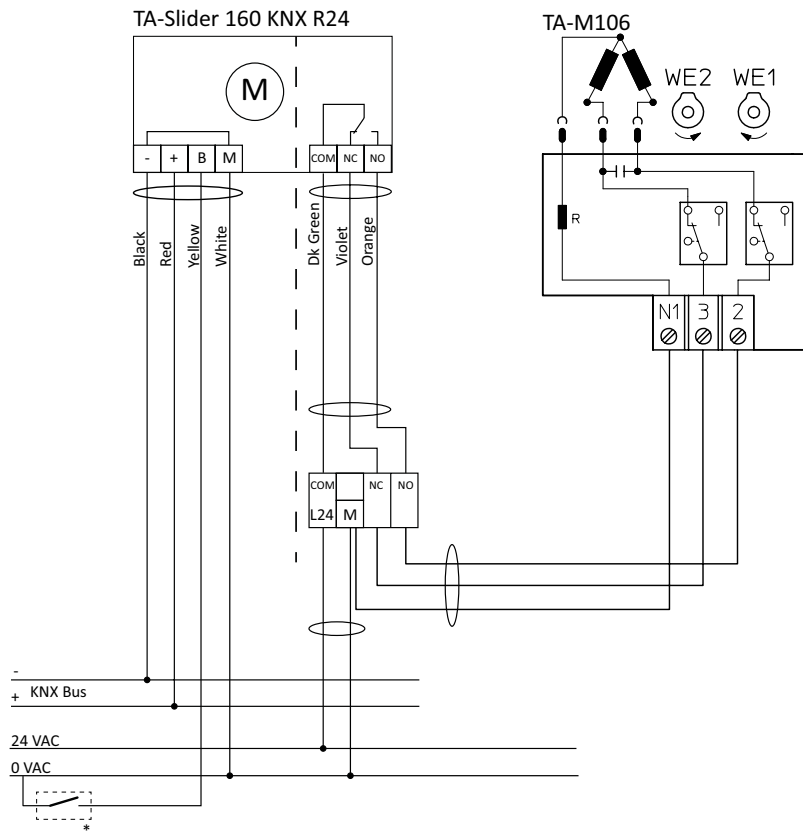

\*) Binary input can be used to toggle between heating and cooling mode as an alternative to toggling by KNX bus.

# TA-Slider 160 BACnet/Modbus CO + TA-M106 CO

(See Application example 1)

Control by BACnet/Modbus

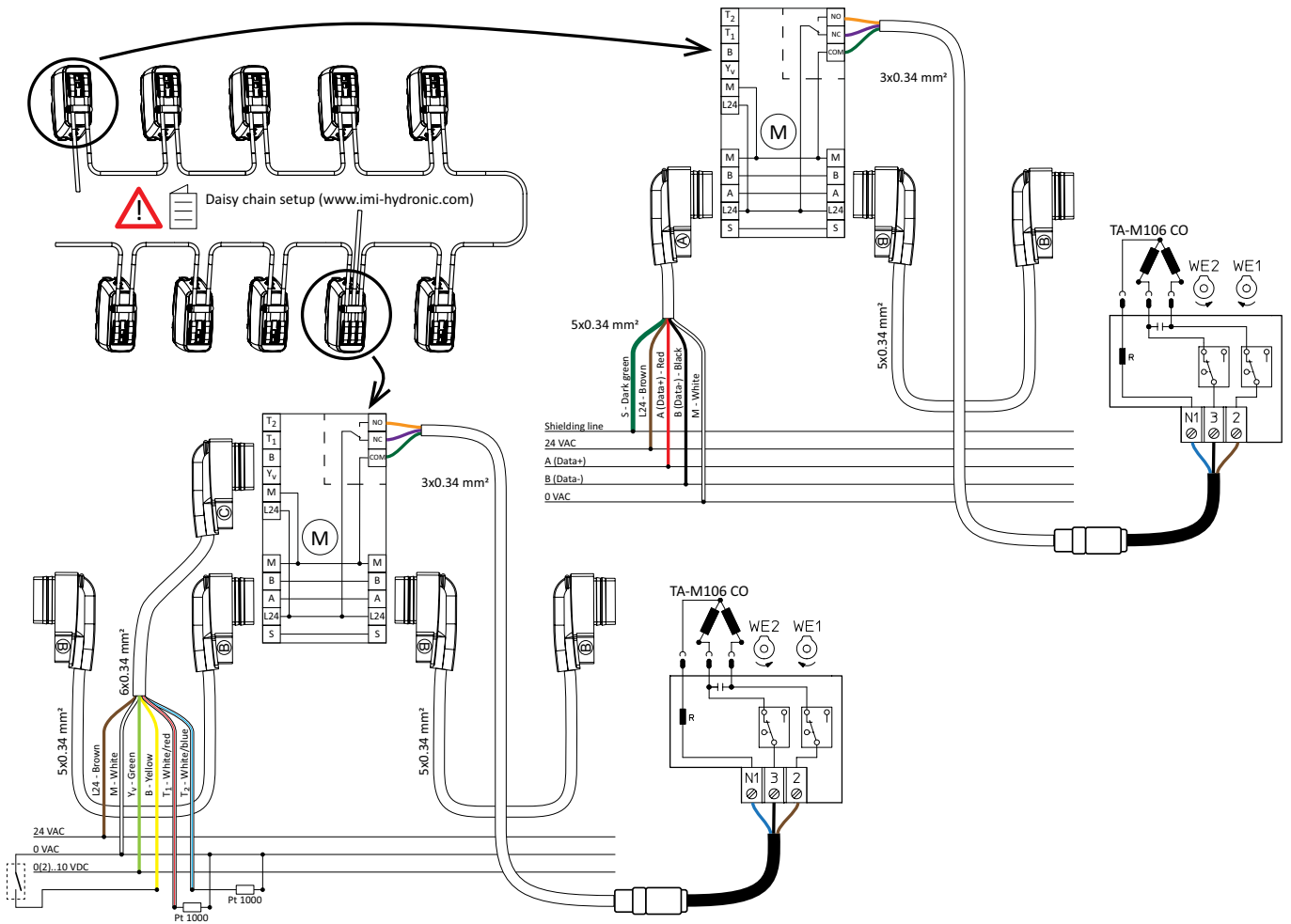

## Diagram

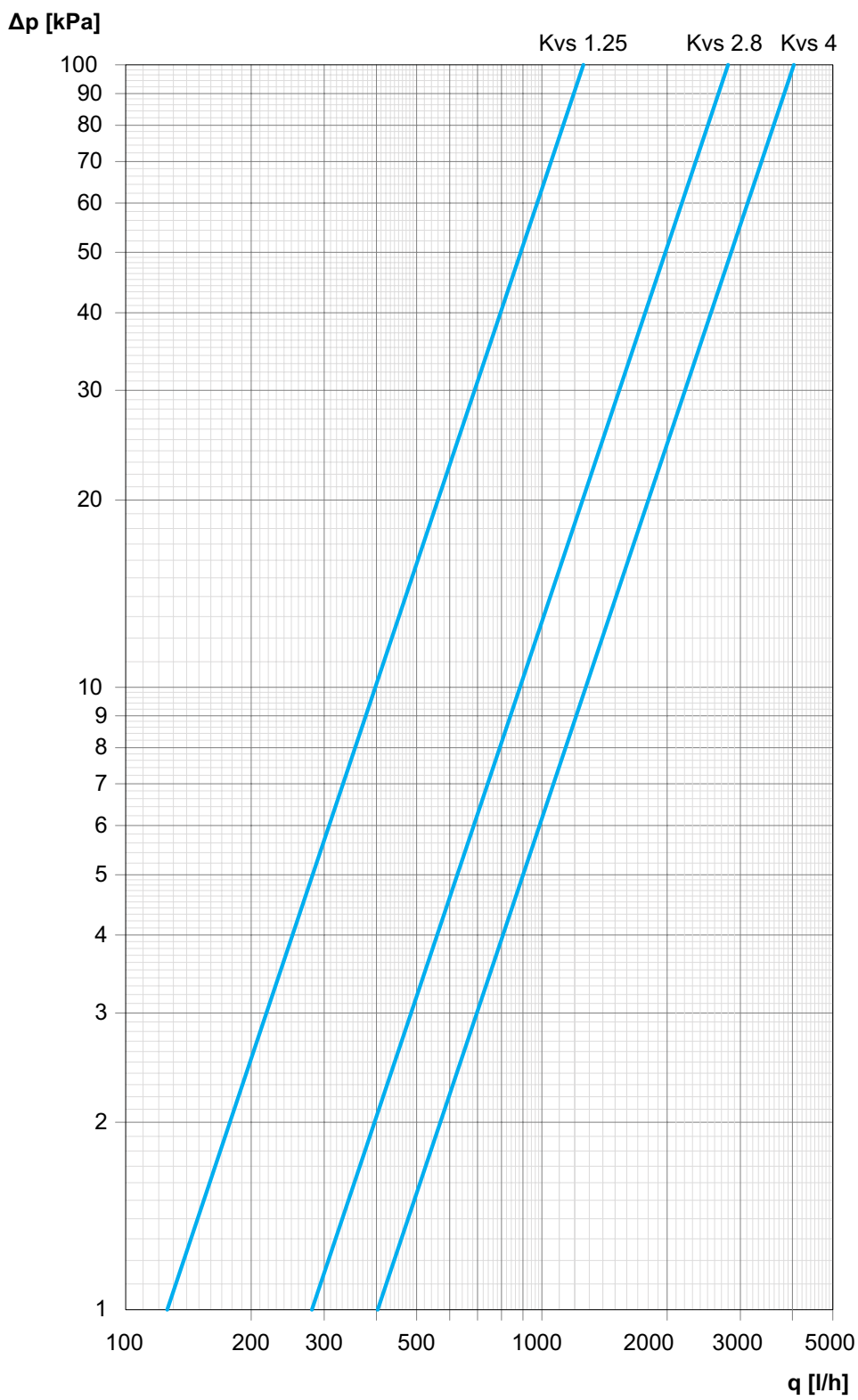

Kvs = Kv of both ball valves fully open (A and B side equal)





## Connections – For flat faced ends

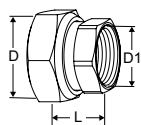

### With Internal thread

Threads according to ISO 228. Thread length according to ISO 7-1.

Swivelling nut

Valve DN	D	D1	L*	EAN	Article No
15	G3/4	G1/2	21	7318794016903	52 163-015

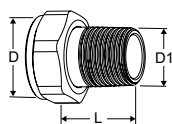

### With External thread

Threads according to ISO 7-1.

Swivelling nut

Valve DN	D	D1	L*	EAN	Article No
15	G3/4	R1/2	29	4024052516612	0601-02.350

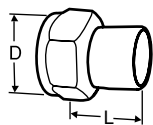

### Welding connection

Swivelling nut

Valve DN	D	Pipe DN	L*	EAN	Article No
15	G3/4	15	36	7318792748509	52 009-015

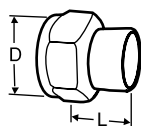

### Soldering connection

Swivelling nut

Valve DN	D	Pipe Ø	L*	EAN	Article No
15	G3/4	15	13	7318792749308	52 009-515
15	G3/4	16	13	7318792749407	52 009-516

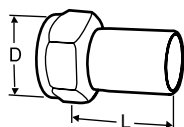

### Connection with smooth end

For connection with press coupling

Swivelling nut

Valve DN	D	Pipe Ø	L*	EAN	Article No
15	G3/4	15	39	7318793810601	52 009-315

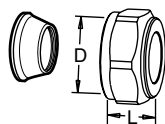

### Compression connection

Support bushes shall be used, for more information see catalogue leaflet FPL.

Should not be used with PEX pipes.

Chrome plated

Valve DN	D	Pipe Ø	L**	EAN	Article No
15	G3/4	15	27	7318793705006	53 319-615
15	G3/4	18	27	7318793705105	53 319-618
15	G3/4	22	27	7318793705204	53 319-622

\*) Fitting length (from the gasket surface to the end of the connection).

\*\*) Over all length L refers to unassembled coupling.

## Connections – For eurocone

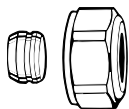

### Compression fitting for copper or steel pipes

For eurocone  
Metal-to-metal sealing  
Support bushes shall be used.

Ø Pipe	EAN	Article No
12	4024052214211	3831-12.351
14	4024052214310	3831-14.351
15	4024052214617	3831-15.351
16	4024052214914	3831-16.351
18	4024052215218	3831-18.351

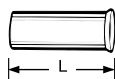

### Support sleeve

for copper or precision steel pipe with a 1 mm wall thickness.  
Brass.

Ø Pipe	L	EAN	Article No
12	25,0	4024052127016	1300-12.170
15	26,0	4024052127917	1300-15.170
16	26,3	4024052128419	1300-16.170
18	26,8	4024052128815	1300-18.170

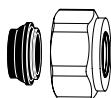

### Compression fitting for copper or steel pipes

For eurocone  
Nickel plated, soft sealing (EPDM)

Ø Pipe	EAN	Article No
15	4024052515851	1313-15.351
18	4024052516056	1313-18.351



### Compression fitting for plastic pipes

For eurocone

Ø Pipe	EAN	Article No
12x1,1	4024052136018	1315-12.351
14x2	4024052134618	1311-14.351
16x1,5	4024052136117	1315-16.351
16x2	4024052134816	1311-16.351
17x2	4024052134915	1311-17.351
18x2	4024052135110	1311-18.351
20x2	4024052135318	1311-20.351



### Compression fitting for multi-layer pipes

For eurocone

Ø Pipe	EAN	Article No
16x2	4024052137312	1331-16.351

## Accessories

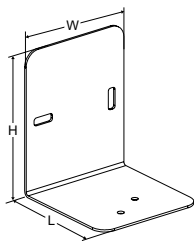

### Bracket

For easier mounting on walls or ceilings.  
2 pcs of M4 screws for fixing the valve to the bracket are included in the package.

L	H	W	EAN	Article No
80	100	80	8016603308032	322031-30000

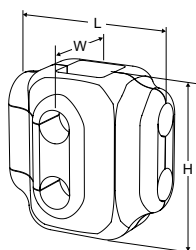

### Insulation

For heating and cooling.  
Max. temperature: 90°C  
Shell thickness: 16 mm.  
Material: Cross-linked polyethylene foam, density external layer 80 kg/m<sup>3</sup>, internal layer 29 kg/m<sup>3</sup>.  
Fire class: B2 – DIN 4102 and 1 – UNI 9177.

Valve DN	L	H	W	EAN	Article No
15	125	125	90	5902276805714	322031-30405
15* / 20	120	140	100	5902276805721	322031-30508

\*) Body marked with DN 20 (connections DN 15).