

# Compresso Connect



## **Pressure maintenance systems with compressors**

For heating systems up to 12 MW  
and cooling systems up to 18 MW

# Compresso Connect

Compresso is a precision pressurisation system with compressors for heating, solar and chilled water systems. It is especially suitable in situations where compactness and precision are required. The system capacity range lies between pressurisation with Statico and Transfero. The new **BrainCube Connect** control panel allows a new level of connectivity, enabling communication with the BMS system, other BrainCubes as well as remote operation of the pressurisation system through live viewing.

## Key features

### > Improved design for an easier and more comfortable operation

Resistant 3.5" TFT illuminated colour touch display. Intuitive and operation-friendly menu. Web based interface with remote control and live view. BrainCube Connect control panel integrated into TecBox.

### > Remote Access and Troubleshooting

Remote access and commissioning support, reducing the need for high skilled staff to perform operations. Quicker response time, reduced repair costs. Data logging for system performance checks.

### > State-of-the-Art Connectivity

Standardised connections to BMS and remote devices available (RS485, Ethernet, USB) enabling time savings during set-up and service and unit controllability. Communication with up to 8 BrainCubes in a Master/Slave network.



## Technical description – Control unit TecBox

### Applications:

Heating, solar and chilled water systems. For systems according to EN 12828, SWKI HE301-01, solar systems according to EN 12976, ENV 12977 with on-site excess temperature protection in case of power blackout.

### Pressure:

Min. admissible pressure, PSmin: 0 bar  
Max. admissible pressure, PS: see Articles

### Temperature:

Max. admissible ambient temperature, TA: 40°C  
Min. admissible ambient temperature, T Amin: 5°C

### Accuracy:

Precision pressure maintenance  $\pm 0,1$  bar.

### Supply voltage:

Compresso C10:  
1 x 230 V (-6% + 10%), 50/60 Hz  
Compresso C15:  
1 x 230 V (-6% + 10%), 50 Hz

### Electric load:

See Articles.

### Enclosure class:

IP 22 according to EN 60529

### Silent-run Compressors:

53-62 dB(A) / 1-10 bar

### Material:

Main materials include steel, brass, and bronze.

### Transportation and storing:

In frostless, dry places.

### Standard:

Constructed according to  
LV-D. 2014/35/EU  
EMC-D. 2014/30/U

---

## Technical description – Expansion vessels

**Applications:**

Only together with Control unit TecBox.  
See Applications under Technical description - Control unit TecBox.

**Media:**

Non-aggressive and non-toxic system media.  
Addition of antifreeze agent up to 50%.

**Pressure:**

Min. admissible pressure, PSmin: 0 bar  
Max. admissible pressure, PS: see Articles

**Temperature:**

Max. admissible bag temperature, TB: 70°C  
Min. admissible bag temperature, TBmin: 5°C

For PED purposes:

Max. admissible temperature, TS: 120°C  
Min. admissible temperature, TSmin: -10°C

**Material:**

Steel. Color beryllium.  
Airproof butyl bag according to EN 13831.

**Transportation and storing:**

In frostless, dry places.

**Standard:**

Constructed according to PED 2014/68/EU.

**Warranty:**

Compresso CG, CG...E: 5-year warranty for the airproof butyl bag.  
Compresso CU, CU...E: 5-year warranty for the vessel.

---

## Function, Equipment, Features

**Control unit TecBox:**

- BrainCube Connect control for an intelligent, fully automatic, safe system operation. Self-optimising with memory function.
- Data logging and system analysis, chronological message memory with prioritisation, remote controllable with live view, periodical automatic selftest.
- Resistive 3.5" TFT illuminated colour touch display. Intuitive, operation-orientated menu layout with slide and tap operation, direct help in pop-up windows. Representation of all relevant parameters and operation status in plaintext and/or graphical, multilingual.
- Silent-run operation.
- Optional water make-up fillsafe monitoring and control through incorporating a Pleno P unit.
- High quality metal cover.
- Floor standing.
- Including assembly kit for the air-side connection of the TecBox with the primary vessel.

**Vessels:**

- Airproof butyl bag (CU, CU...E, CG, CG...E), exchangeable (CG, CG...E).
- Including flex tube for the water-side connection and lock shield valve with ball valve for fast draining (CU, CG).
- Including assembly kit for the air-side connection of the vessels and lock shield valve for the water-side connection with ball valve for fast draining (CU...E, CG...E).
- Corrosion-protected internal coating for minimum bag wear (CG, CG...E).
- Endoscopic inspection opening for internal inspections (CU, CU...E). Two flange openings for internal inspections (CG, CG...E).
- Bag can be vented at the top, condensate drain at the bottom.
- Sinus ring for upright installation.

## Calculation

### Pressure maintenance for systems TAZ ≤ 100°C

Calculation following EN 12828, SWKI HE301-01 \*).

For all special applications like solar systems, district heating systems, systems with temperatures higher than 100°C, cooling systems with temperatures below 5°C please use HySelect software or contact us.

### General equations

<b>Vs</b>	Water capacity of the system	Heating	<b>Vs = vs · Q</b>	vs Q	Specific water capacity, table 4. Installed heat capacity
		Cooling	Vs= Known		System design, content calculation
<b>Ve</b>	Expansion volume	EN 12828	<b>Ve=e · (Vs + Vhs)</b>	e, ehs	Expansion coefficient for $t_{s_{max}}$ , table 1
		Cooling	Ve=e · (Vs + Vhs)	e, ehs	Expansion coefficient for $t_{smax}$ , table 1 <sup>7)</sup>
		SWKI HE301-01 heating	Ve=e · Vs · X <sup>1)</sup> + ehs · Vhs	e ehs	Expansion coefficient for $(t_{smax} + t_r) / 2$ , table 1 Expansion coefficient for $t_{smax}$ , table 1
		SWKI HE301-01 cooling	Ve=e · Vs · X <sup>1)</sup> + ehs·Vhs	e, ehs	Expansion coefficient for $t_{smax}$ , table 1 <sup>7)</sup>
<b>Vwr</b>	Water reserve	EN 12828, Cooling	<b>Vwr ≥ 0,005 · Vs ≥ 3 L</b>		
		SWKI HE301-01	Vwr is considered in Ve with the coefficient X		
<b>p0</b>	Minimum pressure <sup>2)</sup> Lower limit value for the pressure maintenance	EN 12828, Cooling	<b>p0 = Hst/10 + 0,2 bar ≥ pz</b>	Hst	Static height
		SWKI HE301-01	p0=Hst/10 +0.3 bar ≥ pz	pz	Minimum required equipment pressure for pumps or boilers
<b>pa</b>	Initial pressure Lower threshold for an optimum pressure maintenance		<b>pa ≥ p0 + 0,3 bar</b>		
<b>pe</b>	Final pressure Upper threshold for an optimum pressure maintenance.			psvs dpsvs <sub>c</sub>	Response pressure safety valve system Closing pressure tolerance of the safety valve
		EN 12828	<b>pe ≤ psvs - dpsvs<sub>c</sub></b>	dpsvs <sub>c</sub> dpsvs <sub>c</sub>	= 0,5 bar for psvs ≤ 5 bar <sup>4)</sup> = 0,1 · psvs for psvs > 5 bar <sup>4)</sup>
		cooling	<b>pe ≤ psvs - dpsvs<sub>c</sub></b>	dpsvs <sub>c</sub> dpsvs <sub>c</sub>	= 0,6 bar for psvs ≤ 3 bar <sup>4)</sup> = 0,2 · psvs for psvs > 3 bar <sup>4)</sup>
		SWKI HE301-01 heating	<b>pe ≤ psvs/1.3</b> <b>pe ≤ psvs/1.15</b>		for psvs ≤ 3 bar <sup>4)</sup> for psvs > 3 bar <sup>4)</sup>
		SWKI HE301-01 cooling	<b>pe ≤ psvs/1.3 and</b> <b>pe ≤ psvs - 0.6 bar</b>		psvs <sup>4)</sup>

### Compresso

<b>pe</b>	Final pressure Upper threshold for an optimum pressure maintenance.		<b>pe=pa+0,2</b>		
<b>VN</b>	Nominal volume of the expansion vessel <sup>5)</sup>	EN 12828, Cooling	<b>VN ≥ (Ve + Vwr + 2<sup>3)</sup> · 1,1</b>		
		SWKI HE301-01	<b>VN ≥ (Ve + 2<sup>3)</sup> · 1,1</b>		
<b>TecBox</b>			<b>Q = f(Hst)</b>		>> Quick selection Compresso

1) Heating, Cooling, Solar: Q ≤ 10 kW: X = 3 | 10 kW < Q ≤ 150 kW: X = (87-0,3 · Q)/28 | Q > 150 kW: X = 1,5

Geothermal probe systems: X = 2,5

2) The formula for minimum pressure p0 applies to the installation of pressure maintenance on the suction side of the circulation pump. In case of a pressure-side installation p0 is to be increased by the pump pressure Δp.

3) Add 2 litres when a Vento is installed in the system.

4) The safety valves must operate within these limits. Use component tested and certified safety valves of type H and DGH for heating systems, type F for cooling systems.

5) Please select a vessel with an equal or higher nominal volume.

7) Max. system standstill temperature, usually 40°C for cooling applications and geothermal probes with ground regeneration, 20°C for other geothermal probes

\*) SWKI HE301-01: Valid for Switzerland

HySelect calculation software is based on an advanced calculation method and database. Results may vary.

**Table 1: e expansion coefficient**

<b>t (TAZ, ts<sub>max</sub>, tr, ts<sub>min</sub>), °C</b>	<b>20</b>	<b>30</b>	<b>40</b>	<b>50</b>	<b>60</b>	<b>70</b>	<b>80</b>	<b>90</b>	<b>100</b>	<b>105</b>	<b>110</b>
<b>e Water</b> = 0°C	0,0016	0,0041	0,0077	0,0119	0,0169	0,0226	0,0288	0,0357	0,0433	0,0472	0,0513
<b>e % weight MEG*</b>											
30% = -14,5°C	0,0093	0,0129	0,0169	0,0224	0,0286	0,0352	0,0422	0,0497	0,0577	0,0620	0,0663
40% = -23,9°C	0,0144	0,0189	0,0240	0,0300	0,0363	0,0432	0,0505	0,0582	0,0663	0,0706	0,0750
50% = -35,6°C	0,0198	0,0251	0,0307	0,0370	0,0437	0,0507	0,0581	0,0660	0,0742	0,0786	0,0830
<b>e % weight MPG**</b>											
30% = -12,9°C	0,0151	0,0207	0,0267	0,0333	0,0401	0,0476	0,0554	0,0639	0,0727	0,0774	0,0823
40% = -20,9°C	0,0211	0,0272	0,0338	0,0408	0,0481	0,0561	0,0644	0,0731	0,0826	0,0873	0,0924
50% = -33,2°C	0,0288	0,0355	0,0425	0,0500	0,0577	0,0660	0,0747	0,0839	0,0935	0,0985	0,1036

**Table 4: vs approx. water capacity \*\*\* of central heating referred to the installed heat capacity Q**

<b>ts<sub>max</sub>   tr</b>	<b>°C</b>	<b>90   70</b>	<b>80   60</b>	<b>70   55</b>	<b>70   50</b>	<b>60   40</b>	<b>50   40</b>	<b>40   30</b>	<b>35   28</b>
Radiators	vs liter/kW	14,0	16,5	20,1	20,6	27,9	36,6	-	-
Flat radiators	vs liter/kW	9,0	10,1	12,1	11,9	15,1	20,1	-	-
Convectors	vs liter/kW	6,5	7,0	8,4	7,9	9,6	13,4	-	-
Air handlers	vs liter/kW	5,8	6,1	7,2	6,6	7,6	10,8	-	-
Floor heating	vs liter/kW	10,3	11,4	13,3	13,1	15,8	20,3	29,1	37,8

\*) MEG = Mono-Ethylene Glycol

\*\*) MPG = Mono-Propylene Glycol

\*\*\*) Water capacity = heat generator + distribution net + heat emitters

## Temperatures

<b>ts<sub>max</sub></b>	<b>Maximum system temperature</b> Maximum temperature for the calculation of the volume expansion. For heating systems the dimensioned flow temperature at which a heating system is to be operated with the lowest outside temperature to be assumed (standard outside temperature according to EN 12828). For cooling systems the max. temperature that is achieved due to the operation mode or standstill, for solar systems the temperature up to which an evaporation is to be avoided.
<b>ts<sub>min</sub></b>	<b>Lowest system temperature</b> Lowest temperature for calculating expansion volumes. The lowest system temperature is equal to the freezing point. It is dependant on the percentage of antifreeze additives. For water without additives t <sub>min</sub> = 0.
<b>tr</b>	<b>Return temperature</b> Return temperature of the heating system with the lowest outside temperature to be assumed (standard outside temperature according to EN 12828).
<b>TAZ</b>	<b>Safety temperature limiter   Safety temperature controller   Temperature limit</b> Safety device according to EN 12828 for the temperature protection of heat generators. If the set temperature limit is exceeded the heating is turned off. Limiters are locked, controllers automatically release the heat supply if the set temperature falls short. Setting value for systems according to EN 12828 ≤ 110 °C.

**Precision pressure maintenance**

Air controlled Compresso minimize the pressure variations between  $p_a$  and  $p_e$ .  
 $\pm 0,1$  bar

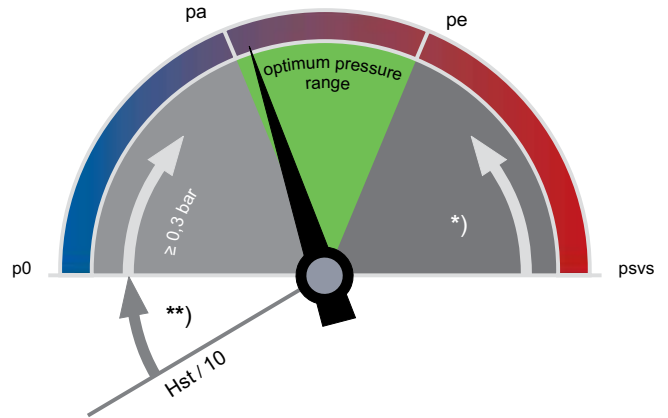

\*\*)

EN 12828, Solar, Cooling:  $\geq 0,2$  bar  
 SWKI HE301-0:  $\geq 0,3$  bar

\*)

EN 12828:  $\geq psvs \cdot 0,1 \geq 0,5$  bar  
 Solar, Cooling:  $\geq psvs \cdot 0,2 \geq 0,6$  bar  
 SWKI HE301-01 Heating  $\geq psvs \cdot (1-1/1,15) \geq 0,3$  bar  
 SWKI HE301-01 Cooling, Solar, Heat Pumps  $\geq psvs \cdot (1-1/1,3) \geq 0,6$  bar

**p0 Minimum pressure**

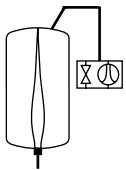

**Compresso**

$p_0$  and the switching points are calculated by the BrainCube.

**pa Initial pressure**

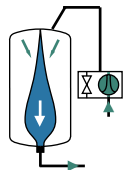

**Compresso**

If the system pressure is  $< p_a$ , the compressor starts.  
 $p_a = p_0 + 0,3$

**pe Final pressure**

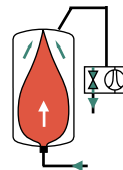

**Compresso**

If system pressure is  $> p_e$  the air relief valve opens.  
 $p_e = p_a + 0,2$

**Table 5: DNe standard values for expansion pipes with Compresso**

Length up to approx. 30 m	DNe	20	25	32	40	50	65	80
<b>Heating:</b>								
EN 12828	Q   kW	1000	1700	3000	3900	6000	11000	15000
SWKI HE301-01 *)	Q   kW	300	600	900	1400	3000	6000	9000
<b>Cooling:</b>								
$t_{s\_max} \leq 50$ °C	Q   kW	1600	2700	4800	6300	9600	17600	24100

\*) Valid for Switzerland

## Quick selection

Heating systems TAZ ≤ 100°C, without addition of antifreeze, EN 12828.

Q [kW]	TecBox				Primary vessel			
	1 compressor	2 compressors	1 compressor	2 compressors	Radiators		Flat radiators	
	C 10.1	C 10.2	C 15.1	C 15.2	90   70	70   50	90   70	70   50
	Static height Hst **) [m]				Nominal volume VN [liter]			
≤ 300	47,1	47,1	82,4	82,4	200	200	200	200
400	47,1	47,1	82,4	82,4	300	300	200	200
500	47,1	47,1	82,4	82,4	300	300	200	200
600	46,0	47,1	81,2	82,4	400	400	300	300
700	<b>42,0</b>	47,1	72,8	82,4	<b>500</b>	500	300	300
800	38,5	47,1	66,0	82,4	500	500	400	300
900	35,6	47,1	60,4	82,4	600	600	400	400
1000	33,0	47,1	55,7	82,4	600	600	400	400
1100	30,8	46,7	51,6	82,4	800	800	500	400
1200	28,7	44,3	48,0	82,4	800	800	500	500
1300	26,9	42,1	44,8	82,4	800	800	500	500
1400	25,2	40,2	42,0	78,1	1000	1000	600	500
1500	23,7	38,4	39,5	74,1	1000	1000	600	600
2000	17,6	31,3	29,7	59,0	1500	1500	800	800
2500	13,1	26,3	23,0	48,9	1500	1500	1000	1000
3000	9,6	22,4	18,0	41,5	2000	2000	1500	1500
3500	-	19,3	14,1	35,7	3000	3000	1500	1500
4000	-	16,7	10,9	31,1	3000	3000	2000	1500
4500	-	14,5	8,2	27,3	3000	3000	2000	2000
5000	-	12,6	-	24,1	3000	3000	2000	2000
5500	-	10,9	-	21,3	4000	4000	3000	2000
6000	-	9,4	-	18,8	4000	4000	3000	3000
6500	-	8,0	-	16,7	4000	4000	3000	3000
7000	-	-	-	14,7	5000	5000	3000	3000
8000	-	-	-	11,4	5000	5000	4000	3000
9000	-	-	-	8,6			4000	4000
10000	-	-	-	6,3			4000	4000

\*\*) With SWKI HE301-01 the value decreases with 1m

### Example

Q = 700 kW  
Radiators 90 | 70 °C  
TAZ = 100 °C  
Hst = 35 m  
psvs = 6 bar

Selected:  
TecBox C 10.1-6  
Primary vessel CU 500.6

Setting of BrainCube:

Hst = 35 m  
TAZ = 100 °C

Check safety valve psvs:

for TAZ = 100 °C

EN 12828: psvs:  $(35/10 + 0,7) \cdot 1,11 = 4,66 < 6$  o.k.

SWKI HE301-01: psvs:  $(35/10 + 0,8) \cdot 1,15 = 4,95 < 6$  o.k.

### Setting values

for TAZ, Hst and psv in the "Parameter" menu of the BrainCube.

			TAZ = 100 °C	TAZ = 105 °C	TAZ = 110 °C
EN 12828	Check psv:	for psv ≤ 5 bar	psv ≥ 0,1 · Hst + 1,2	psv ≥ 0,1 · Hst + 1,4	psv ≥ 0,1 · Hst + 1,6
		for psv > 5 bar	psv ≥ (0,1 · Hst + 0,7) · 1,11	psv ≥ (0,1 · Hst + 0,9) · 1,11	psv ≥ (0,1 · Hst + 1,1) · 1,11
SWKI HE301-01		for psv ≤ 3 bar	psv ≥ (0,1 · Hst + 0,8) · 1,3	psv ≥ (0,1 · Hst + 1,0) · 1,3	psv ≥ (0,1 · Hst + 1,2) · 1,3
		for psv > 3 bar	psv ≥ (0,1 · Hst + 0,8) · 1,15	psv ≥ (0,1 · Hst + 1,0) · 1,15	psv ≥ (0,1 · Hst + 1,2) · 1,15

## Equipment

### Expansion pipes

According to table 5. With multiple vessels to be calculated depending on the output per vessel.

### Lock shield valve DLV

Included with delivery.

### Zeparo

Air vent Zeparo ZUT or ZUP at each high point for venting during the filling and during the draining process. Separator for dirt and magnetite in each system in the main return to the heat generator. If no central degassing (Vento V Connect) is installed a micro bubble separator can be installed in the main flow if possible before the circulation pump.

The static height,  $H_{st,m}$ , according to the following table above the micro bubble separators, must not be exceeded.

$t_{s,max}$   °C	90	80	70	60	50	40	30	20	10
$H_{st,m}$   mWs	15,0	13,4	11,7	10,0	8,4	6,7	5,0	3,3	1,7

## Application examples

### Compresso C 10.1 Connect

TecBox with 1 compressor ground standing beside the primary vessel, precision pressure maintenance  $\pm 0,1$  bar with Pleno P water make-up

### For heating systems up to approx. 6 500 kW

(May require changes to meet local legislation)

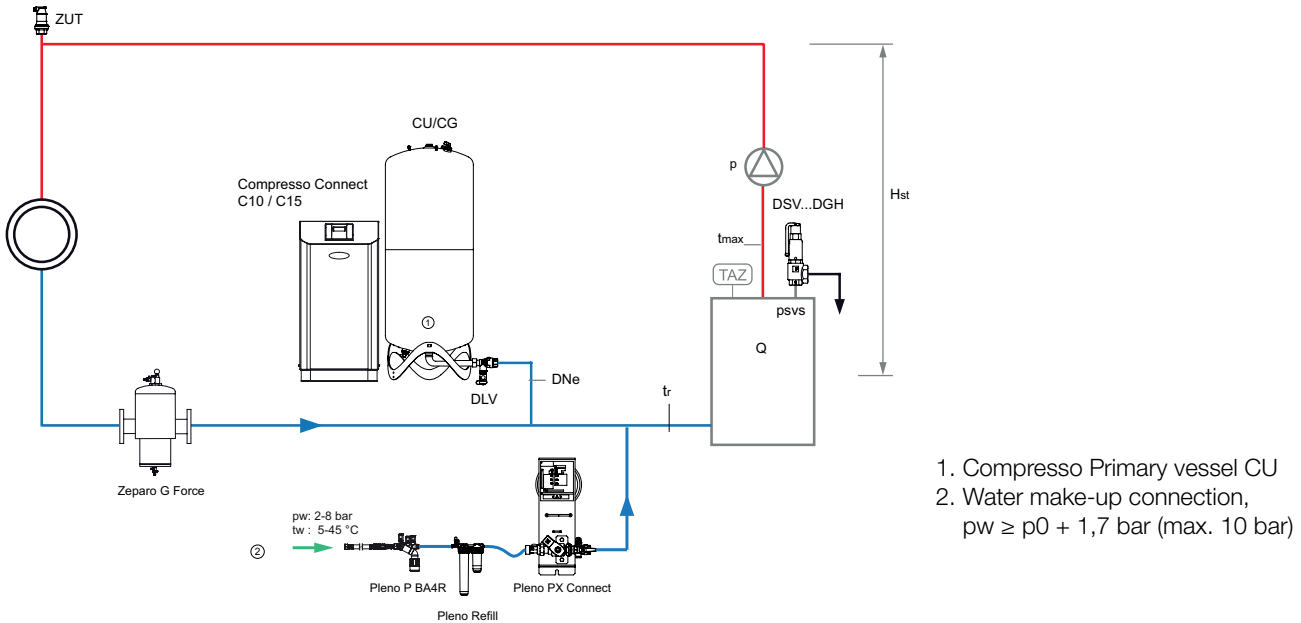

**Zeparo G Force** cyclonic dirt separator with magnet ZIMA in the return.

**Zeparo ZUT** for automatic venting during filling and during draining.

**Further accessories, product and selection details, see:** Datasheet *Pleno, Zeparo and Accessories*.

## Installation

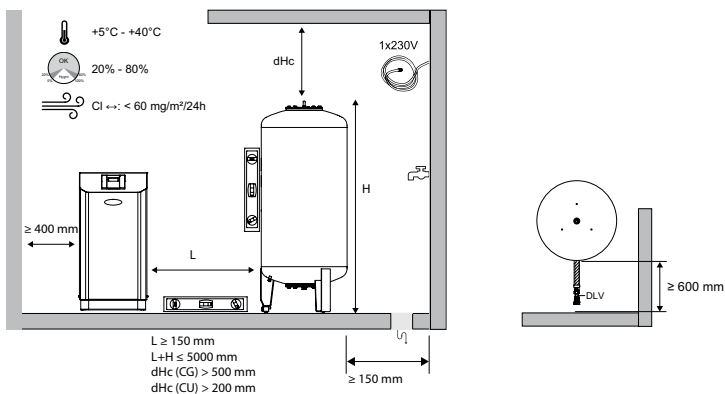



## Control unit TecBox, Compresso C 10 Connect

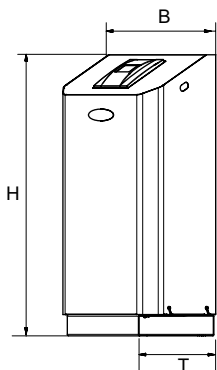

### Compresso C 10.1 Connect

Precision pressure maintenance  $\pm 0.1$  bar  
1 compressor. Valve manifold with 1 spill valve and safety valve.

Type	PS [bar]	B	H	T	m [kg]	Pel [kW]	EAN	Article No
C 10.1-3.0	3	520	1060	350	21	0,6	7640161629042	810 1420
C 10.1-3.75	3,75	520	1060	350	21	0,6	7640161628182	810 1421
C 10.1-4.2	4,2	520	1060	350	21	0,6	7640161629059	810 1422
C 10.1-5.0	5	520	1060	350	21	0,6	7640161628199	810 1423
C 10.1-6.0	6	520	1060	350	21	0,6	7640161628205	810 1424

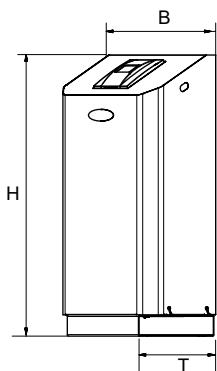

### Compresso C 10.2 Connect

Precision pressure maintenance  $\pm 0.1$  bar  
2 compressors. Valve manifold with 1 spill valve and safety valve. Switching is time and load dependant.

Type	PS [bar]	B	H	T	m [kg]	Pel [kW]	EAN	Article No
C 10.2-3.0	3	520	1060	350	35	1,2	7640161629066	810 1460
C 10.2-3.75	3,75	520	1060	350	35	1,2	7640161628236	810 1461
C 10.2-4.2	4,2	520	1060	350	35	1,2	7640161629073	810 1462
C 10.2-5.0	5	520	1060	350	35	1,2	7640161628243	810 1463
C 10.2-6.0	6	520	1060	350	35	1,2	7640161628250	810 1464

T = Depth of the device

## Control unit TecBox, Compresso C 15 Connect

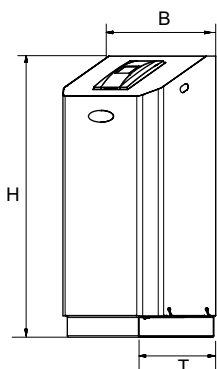

### Compresso C 15.1 Connect

Precision pressure maintenance  $\pm 0.1$  bar  
1 compressor. Valve manifold with 1 spill valve and safety valve.

Type	PS [bar]	B	H	T	m [kg]	Pel [kW]	EAN	Article No
C 15.1-6.0	6	520	1060	350	42	1,3	7640161628212	810 1434
C 15.1-10.0	10	520	1060	350	42	1,3	7640161628229	810 1435

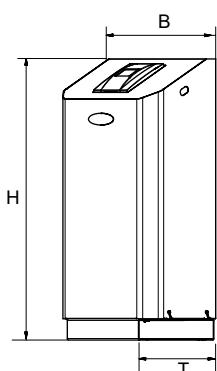

### Compresso C 15.2 Connect

Precision pressure maintenance  $\pm 0.1$  bar  
2 compressors. Valve manifold with 1 spill valve and safety valve. Switching is time and load dependant.

Type	PS [bar]	B	H	T	m [kg]	Pel [kW]	EAN	Article No
C 15.2-6.0	6	520	1060	350	62	2,6	7640161628267	810 1474
C 15.2-10.0	10	520	1060	350	62	2,6	7640161628274	810 1475

T = Depth of the device

## Expansion vessels

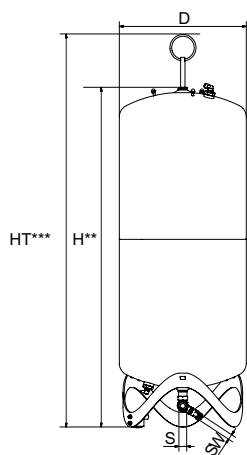

### Compresso CU

Primary vessel. Measuring foot for content measurement. Including flex tube for the water-side connection and lock shield valve with ball valve for fast draining.

Type	VN [l]	D	H**	HT***	m [kg]	S	Sw	EAN	Article No
<b>6 bar (PS)</b>									
CU 200.6	200	500	1340	1565	34	Rp1	G3/4	7640148630771	712 1000
CU 300.6	300	560	1469	1690	40	Rp1	G3/4	7640148630788	712 1001
CU 400.6	400	620	1532	1760	58	Rp1	G3/4	7640148630795	712 1002
CU 500.6	500	680	1627	1858	67	Rp1	G3/4	7640148630801	712 1003
CU 600.6	600	740	1638	1873	80	Rp1	G3/4	7640148630818	712 1004
CU 800.6	800	740	2132	2360	98	Rp1	G3/4	7640148630825	712 1005

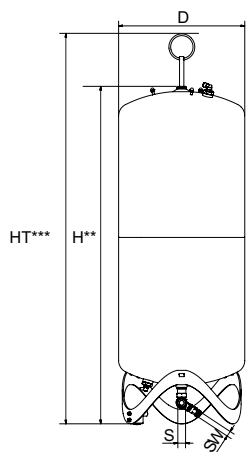

### Compresso CU...E

Secondary vessel. Including flex tube for the water-side connection and lock shield valve with ball valve for fast draining, assembly kit for the air-side connection of the vessels.

Type	VN [l]	D	H*	HT***	m [kg]	S	Sw	EAN	Article No
<b>6 bar (PS)</b>									
CU 200.6 E	200	500	1340	1565	33	Rp1	G3/4	7640148630832	712 2000
CU 300.6 E	300	560	1469	1690	39	Rp1	G3/4	7640148630849	712 2001
CU 400.6 E	400	620	1532	1760	57	Rp1	G3/4	7640148630856	712 2002
CU 500.6 E	500	680	1627	1858	66	Rp1	G3/4	7640148630863	712 2003
CU 600.6 E	600	740	1638	1873	79	Rp1	G3/4	7640148630870	712 2004
CU 800.6 E	800	740	2132	2360	97	Rp1	G3/4	7640148630887	712 2005

VN = Nominal volume

\*\*\*) Tolerance 0 /-100.

\*\*\*) Max. height when vessel is tilted

### Compresso CG

Primary vessel. Measuring foot for content measurement. Including flex tube for the water-side connection and lock shield valve with ball valve for fast draining. Corrosion-protected internal coating for minimum bag wear.

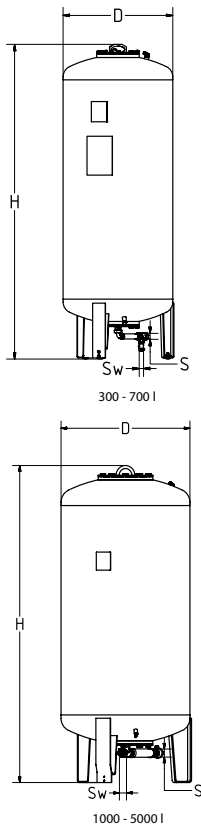

Type*	VN [l]	D	H**	H***	m [kg]	S	Sw	EAN	Article No
<b>6 bar (PS)</b>									
CG 300.6	300	500	1823	1839	140	Rp1	G3/4	7640148630894	712 1006
CG 500.6	500	650	1864	1893	190	Rp1	G3/4	7640148630900	712 1007
CG 700.6	700	750	1894	1931	210	Rp1	G3/4	7640148630917	712 1008
CG 1000.6	1000	850	2097	2132	290	Rp1 1/2	G3/4	7640148630924	712 1009
CG 1500.6	1500	1016	2248	2295	400	Rp1 1/2	G3/4	7640148630931	712 1010
CG 2000.6	2000	1016	2746	2785	680	Rp1 1/2	G3/4	7640148630948	712 1015
CG 3000.6	3000	1300	2850	2936	840	Rp1 1/2	G3/4	7640148630955	712 1012
CG 4000.6	4000	1300	3496	3547	950	Rp1 1/2	G3/4	7640148630962	712 1013
CG 5000.6	5000	1300	4134	4183	1050	Rp1 1/2	G3/4	7640148630979	712 1014
<b>10 bar (PS)</b>									
CG 300.10	300	500	1854	1866	160	Rp1	G3/4	7640148631075	712 3000
CG 500.10	500	650	1897	1921	220	Rp1	G3/4	7640148631082	712 3001
CG 700.10	700	750	1928	1961	250	Rp1	G3/4	7640148631099	712 3002
CG 1000.10	1000	850	2097	2132	340	Rp1 1/2	G3/4	7640148631105	712 3003
CG 1500.10	1500	1016	2285	2331	460	Rp1 1/2	G3/4	7640148631112	712 3004
CG 2000.10	2000	1016	2779	2819	760	Rp1 1/2	G3/4	7640148631129	712 3009
CG 3000.10	3000	1300	2879	2942	920	Rp1 1/2	G3/4	7640148631136	712 3006

### Compresso CG...E

Secondary vessel. Including lock shield valve with ball valve for fast draining, assembly kit for the air-side connection of the vessels. Corrosion-protected internal coating for minimum bag wear.

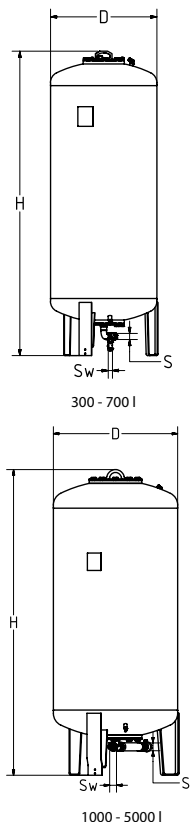

Type*	VN [l]	D	H**	H***	m [kg]	S	Sw	EAN	Article No
<b>6 bar (PS)</b>									
CG 300.6 E	300	500	1823	1839	140	Rp1	G3/4	7640148630986	712 2006
CG 500.6 E	500	650	1864	1893	190	Rp1	G3/4	7640148630993	712 2007
CG 700.6 E	700	750	1894	1931	210	Rp1	G3/4	7640148631006	712 2008
CG 1000.6 E	1000	850	2097	2132	290	Rp1 1/2	G3/4	7640148631013	712 2009
CG 1500.6 E	1500	1016	2248	2295	400	Rp1 1/2	G3/4	7640148631020	712 2010
CG 2000.6 E	2000	1016	2746	2785	680	Rp1 1/2	G3/4	7640148631037	712 2015
CG 3000.6 E	3000	1300	2850	2936	840	Rp1 1/2	G3/4	7640148631044	712 2012
CG 4000.6 E	4000	1300	3496	3547	950	Rp1 1/2	G3/4	7640148631051	712 2013
CG 5000.6 E	5000	1300	4134	4183	1050	Rp1 1/2	G3/4	7640148631068	712 2014
<b>10 bar (PS)</b>									
CG 300.10 E	300	500	1854	1866	160	Rp1	G3/4	7640148631167	712 4000
CG 500.10 E	500	650	1897	1921	220	Rp1	G3/4	7640148631174	712 4001
CG 700.10 E	700	750	1928	1961	250	Rp1	G3/4	7640148631181	712 4002
CG 1000.10 E	1000	850	2097	2132	340	Rp1 1/2	G3/4	7640148631198	712 4003
CG 1500.10 E	1500	1016	2285	2331	460	Rp1 1/2	G3/4	7640148631204	712 4004
CG 2000.10 E	2000	1016	2779	2819	760	Rp1 1/2	G3/4	7640148631211	712 4009
CG 3000.10 E	3000	1300	2879	2942	920	Rp1 1/2	G3/4	7640148631228	712 4006

VN = Nominal volume

\*) Applications > 10 bar and special vessels upon request.

\*\*) Tolerance 0 /-100.

\*\*\*) Max. height when vessel is tilted

## Electrical scheme

230 V/ 50/60 Hz

### Electrical supply Compresso C

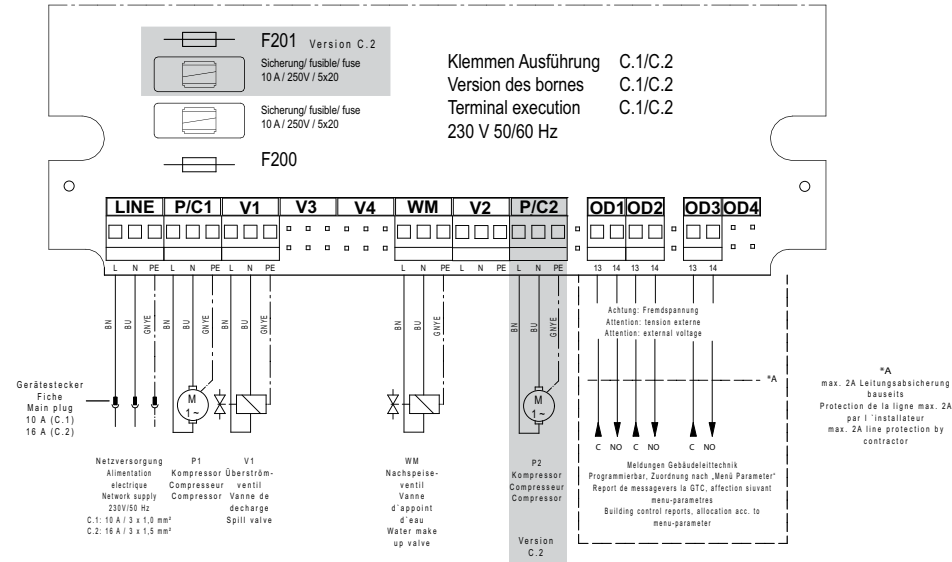

### Safety Extra Low Voltage connections

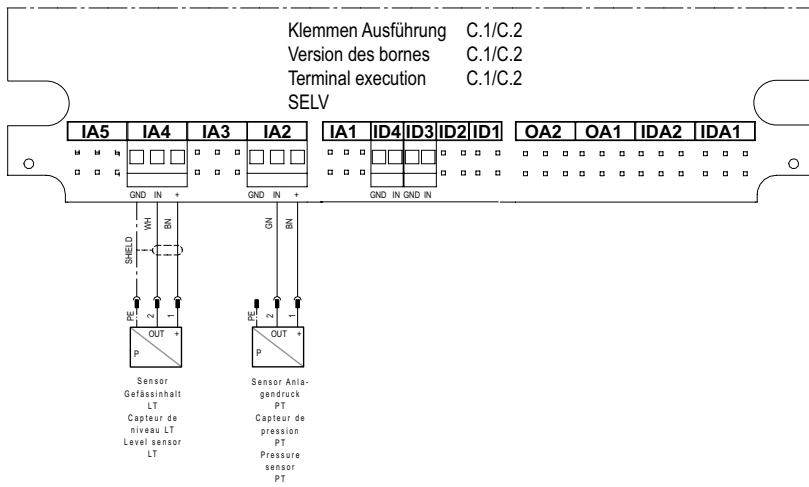

### Communication

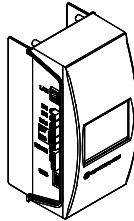
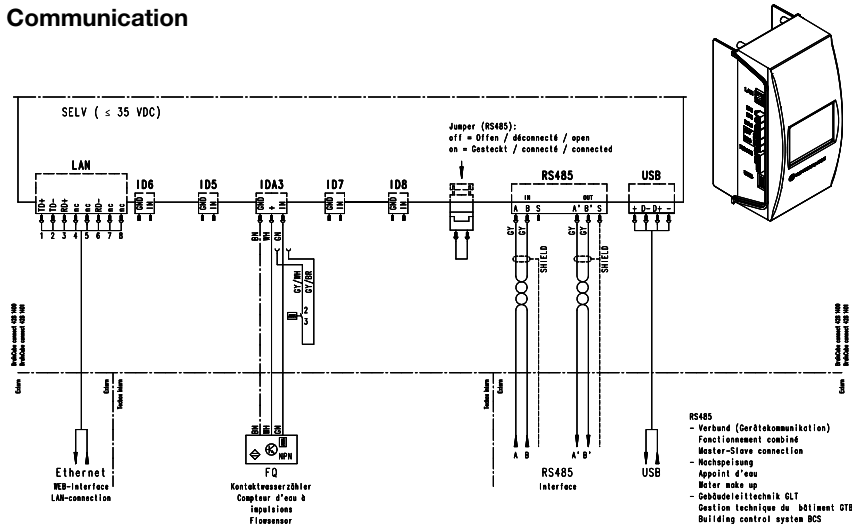

The products, texts, photographs, graphics and diagrams in this document may be subject to alteration by IMI Hydronic Engineering without prior notice or reasons being given. For the most up to date information about our products and specifications, please visit [www.imi-hydronic.com](http://www.imi-hydronic.com).